

2017 ACCESSORIES RIDING GEAR GENUINE PARTS

OUTLANDER
RENEGADE
DEFENDER
MAVERICK
COMMANDER

NEW MAVERICK X3 ACCESSORIES



INTERNATIONAL EDITION

can-am
Can-AmOffRoad.com



WHY CHOOSE CAN-AM ACCESSORIES?

QUALITY & SEAMLESS INTEGRATION.

It's that simple. Our commitment to innovation, high-quality materials and seamless integration means we know exactly what it takes to the accessories for our industry-leading ATVs and Side-by-Side vehicles. Accessories that fit in, fit right, look great, are made to last, and are the only ones that can transform any Can-Am into your Can-Am.

TRUST & RELIABILITY.

Quality and confidence are built into everything we make, even our warranty. That's why off-road enthusiasts trust Can-Am accessories. It's a responsibility we take seriously, so you'll be pleased to know that genuine BRP parts, accessories and riding gear¹ are covered for an entire year² - no matter when they're purchased³. And if it's a BRP Partner aftermarket product and BRP or an authorized dealer sells it, it's also covered⁴! Add to that a 4-year limited warranty on helmets and it's clear: our commitment to quality and to you is rock solid.

In addition, our limited warranty comes with significant added value, because labor and collateral damage to the vehicle may be covered only if the failed part or accessory was installed by a BRP authorized dealer or distributor. We Back Only The Best - Which is why for generations you've trusted us to get you there, and you know you can trust us to keep you going.

PERFORMANCE & PERSONALITY.

Can-Am. It's power, performance, freedom and versatility driven by unrivalled quality and reliability. Can-Am can quench your thirst for adventure and help get things done. Nothing beats our huge range of customized accessories designed to get the most out of every thrill, every mile, and every job.

 [CATCH THE VIDEO AT CAN-AMOFFROAD.COM](https://www.can-am-offroad.com)

VISIT YOUR DEALER TODAY AND CREATE YOUR VERY OWN CAN-AM.

See your local dealer for details.

¹ BRP or BRP Partner accessories purchased at an authorized BRP dealership / distributor. This warranty does not apply to factory-installed accessories. Certain conditions apply. See your local dealer for details.

² From date of purchase.

³ This limited warranty is effective as of March 1st, 2016.

⁴ Under the limited warranty. Applies only to BRP-made products or aftermarket products made by accredited BRP partners.

Warranty periods may vary per your region.



2017 ACCESSORIES RIDING GEAR GENUINE PARTS

Be sure to consult our convenient ATV & Side-by-side vehicle accessory **COMPATIBILITY GUIDES** before outfitting your vehicle.



ATV ACCESSORIES

18 **COMPATIBILITY GUIDE**

OUTLANDER, RENEGADE & OUTLANDER 6 X 6

- 20 CARGO
- 26 WINDSHIELDS
- 28 HANDLEBARS & MIRRORS
- 29 RACKS
- 32 SKID PLATES
- 36 BUMPERS
- 38 LIGHTING & ELECTRICAL
- 41 WINCHES
- 43 HITCHES
- 44 PERFORMANCE
- 48 APACHE 360 TRACK SYSTEMS
- 50 PLOWS
- 57 COVERS, DECALS AND ADD-ONS
- 58 OUTLANDER 6x6 ACCESSORIES

SIDE-BY-SIDE VEHICLE ACCESSORIES

70 **COMPATIBILITY GUIDE**

MAVERICK X3

- 73 ROOFS
- 75 WINDSHIELDS & MIRRORS
- 77 DOORS & REAR WIND PROTECTION
- 78 SKID PLATES
- 79 BUMPERS & PROTECTION
- 84 SEATS
- 85 CARGO & RACKS
- 86 LIGHTING
- 89 ELECTRICAL
- 90 WINCHES & HITCHES
- 90 PERFORMANCE
- 91 COVER

DEFENDER, MAVERICK & COMMANDER

- 98 ROOFS
- 103 WINDSHIELDS & MIRRORS
- 107 DOORS
- 110 REAR WIND PROTECTION
- 113 SKID PLATES
- 117 BUMPERS & PROTECTION
- 132 CARGO & RACKS
- 146 LIGHTING
- 152 ELECTRICAL
- 157 WINCHES & HITCHES
- 160 SEATS
- 161 PERFORMANCE
- 166 APACHE 360 LT TRACK SYSTEM
- 168 PLOWS
- 170 COVERS & ADD-ONS

RIDING GEAR

- 178 SPORTSWEAR
- 183 TEEN & KIDSWEAR
- 184 CYCLOPS GEAR CAMERAS
- 185 HELMETS
- 193 BLUETOOTH COMMUNICATION SYSTEMS
- 194 GOGGLES
- 196 GLOVES
- 197 JERSEYS
- 198 JACKETS & PANTS
- 203 BOOTS
- 205 TECHNOLOGY GUIDE
- 206 TECHNICAL WEAR
- 208 BAGS
- 209 SIZING CHART

TIRES & RIMS

- 171 TIRES
- 173 RIMS

PARTS & MAINTENANCE

- 211 PARTS
- 213 OILS & MAINTENANCE



VISIT US AT CAN-AMOFFROAD.COM

© 2016 Bombardier Recreational Products Inc. (BRP). All rights reserved. ®, ™ and the BRP logo are trademarks of BRP or its affiliates. CARLISLE is a trademark of Carlisle Companies. CHAMUDE and HIPORA are registered trademarks of Kolon Industries, Inc. CLARINO is a trademark of Kuraray Co. Ltd. COOLMAX and THERMOLITE are registered trademarks of INVISTA for durable fabrics. DRIRELEASE is a registered trademark of Optimer Inc. FOX is a registered trademark of Fox Racing Canada. GARMIN and MONTANA are registered trademarks of Garmin Ltd. iPod is a registered trademark of Apple Inc. KOLPIN, GUN BOOT and IMPACT are registered trademarks of Kolpin Powersports Inc. KYB is a registered trademark of Kayaba. MicroSD is a registered trademark of SD Card Association. Mud Lite XTR and SS312 are trademarks of ITP Tires. NEXT G-1 VISTA is a trademark of Next Camo, LLC. NGK is a registered trademark of NGK Spark Plugs, Ltd. PRIMALOFT GOLD and PRIMALOFT BLACK are registered trademarks of Albany International Corp. SUPERWINCH and S SUPERWINCH (design) are registered trademarks of Superwinch LLC. TEFLON, TEFLON HT and KEVLAR are trademarks of E.I. DuPont de Nemours & Co. TWINAIR is a trademark of Twin Air USA UNI is a trademark of UNIFILTER Inc. VELCRO is a registered trademark of Velcro Industries. WARN is a trademark of Warn Industries Inc. YUASA is a registered trademark of YUASA Batteries Inc. ZILLA and BIGHORN 2.0 are trademarks of Maxxis. SCOTT is a trademark of Scott Sports SA. The following trademarks are the property of their respective owners: BLUETOOTH, CREE, DURO, DWT, HELLA, ITP, KENDA, MOSSY OAK, RAM, SUR LAST, VISION, XPS and YOSHIMURA. DRAGONFIRE is a trademark of KRANSCO. Baja Designss is a registered trademark of Baja Designss Inc. S3 POWERSPORTS is a trademark of S3 Power Sports LLC. Some models depicted herein may include optional equipment. Prices, if shown, are based on Manufacturer Suggested Retail Prices. Dealers may sell for a different price. For Canada & US, taxes are not included. Depending on location, products are distributed by BRP US Inc., Bombardier Recreational Products Inc., BRP European Distribution SA, BRP Finland Oy, BRP Australia Pty Ltd. or BRP Brasil Motorsports LTDA. BRP reserves the right, at any time, to discontinue or change specifications, prices, designs, features, equipment without incurring obligation. Printed in Canada.

GOING GLOBAL

This catalog, global in nature, shares BRP's full parts, accessories and clothing product offering. Some products may not be available in your country, due to different climates (ie.no snow), local certifications and/or legal requirements. Contact your BRP dealer for local specifics.



A HUNT IS A SERIOUS THING.

Be ready for anything with our extensive collection of vehicle accessories that'll help you make quick work of any prey, any day. The chase is on...



ATV ACCESSORIES P. 12



SIDE-BY-SIDE VEHICLE ACCESSORIES P. 64



SPORTSWEAR & RIDING GEAR P. 176



RIGHT FOR THE JOB.

Nothing's done until it's done, and you never run out of things to do. Thankfully we're not about to run out of great accessories that'll help you with any of those jobs.



ATV ACCESSORIES P. 12



SIDE-BY-SIDE VEHICLE ACCESSORIES P. 64



SPORTSWEAR & RIDING GEAR P. 176



ADVENTURE TASTES BETTER WHEN SHARED WITH FRIENDS.

There's just something about getting out, and getting away, and nothing makes it easier, or more fun than the right accessories and gear.



ATV ACCESSORIES P. 12



SIDE-BY-SIDE VEHICLE ACCESSORIES P. 64



SPORTSWEAR & RIDING GEAR P. 176



PUMP IT UP.

The new Maverick X3 accessories offer an entirely new level of enjoyment and are designed to enhance your machine's already impressive comfort and great looks.



MAVERICK X3 ACCESSORIES P. 72-91

EXPERT PARTNERSHIPS DELIVER EXCITING PRODUCTS.

In 2017, Can-Am is making the most of its association with world-class partners. Together we'll be bringing the very best in side-by-side gear and accessories that'll make it a year to remember.



CGX2



CG360



CYCLOPSGEAR

CATCH ALL THE ACTION

It'll be easier, and more exciting than ever to catch all the action thanks to our new association with Cyclops Gear. When it comes to high-tech, high-action ultra-durable cameras, Cyclops Gear has it hands down.

We'll be putting their feature-packed CGX2 and CG360 cameras front and center – both ride on the cutting edge of innovative action cams, and together with Can-Am the results are going to be pure adrenaline.

SEE P.184



RACING-INSPIRED EXCELLENCE THAT'S CUSTOM CAN-AM!

BRP and Lonestar Racing are teaming up to offer Can-Am side-by-side drivers an unparalleled range of distinctive racing-inspired performance accessories including several designed for the all-new Maverick X3.

It's an opportunity to get your hands on premium Commander, Maverick and Maverick X3 components that look great and ride tough: aluminum roofs, bumpers, intrusion bars and much more, all exclusively for Can-Am, available in matching Can-Am colors. It's going to be a win-win year for side-by-side drivers who ride on the edge!



SEE P.74, 80, 88, 91, 124, 125, 163



STYLE & COMFORT RIDE SEAT!

Beard, among the leading aftermarket seat manufacturers, is offering exceptional seat packages for Can-Am side-by-side vehicles including an exclusive design engineered for the all-new Maverick X3 and available in 3 matching colors.

Sold in pairs, these innovative welded-steel frame seats are stylish and rugged. Designed to absorb impacts, they're 4-point-harness compatible, offering enhanced side containment that secures the occupant so that they can focus on their drive and not on staying balanced while maneuvering over rough terrain.

SEE P.84, 160



For Maverick X3

For Maverick and Commander



BRIGHT LIGHTS FOR MAVERICK X3!

Baja Designs engineers are considered to be the "Scientists of Lighting" in racing circles. They're the standard bearers for innovative motorcycle and automobile lighting, and a great option for your Can-Am vehicle as well.

Baja Design and Can-Am are in lockstep, ensuring our Maverick X3 benefit from superior lighting technology that looks great, and works flawlessly. It's clear: Baja Designs truly are lighting the way ahead.

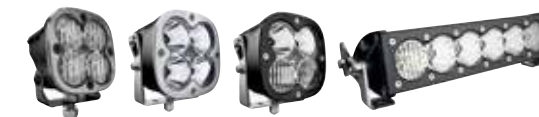

SEE P.86, 87



THE ONLY WAY TO GET DOWN AND DIRTY!

Great partners are inspiring – like S3. In 2016 S3 has put its energy and passion for powersports into outstanding accessories for our Defender.

S3 understands, and that's why we're proud of our association with them. They're mad for mud and absolutely obsessed with creating high-quality, trail-tough, work-ready accessories that are practical, and practically indestructible. Time to hit the dirt!

SEE P.121, 164



DEFENDER-TOUGH PROTECTION ALL THE WAY!

Dragonfire is making quite a name for itself for its world-class off-road accessories. Tough and built to last, they're proof that Dragonfire has got the drive and determination to be a select Can-Am partner.

Dragonfire's exceptional range of customized body protection and convenience components are designed specifically for our Defender side-by-side vehicles, and they won't disappoint. And it's only the beginning, because Dragonfire never stops thinking, and we never stop giving them reasons to innovate and excel.

SEE P.122, 123



LinQ 11.5 GAL (43L)
AUDIO CARGO BOX
P. 23



FLIP GLASS WINDSHIELD
P. 103



LONESTAR RACING ALUMINUM ROOF
P. 100
BEARD SEATS
P. 160



COMPLETE RANCHER PROTECTION KIT
P. 36



LinQ LOW PROFILE BASKET
P. 134



WARN PROVANTAGE WINCH
P. 157



LADIES' XC-4 HELMET
P. 187



39" (99 CM) DOUBLE STACKED
LED LIGHT BAR (270 WATTS)
P. 146

CAN-AM ATV ACCESSORIES

EXTRA EXCITEMENT & ADDED CONVENIENCE

And we've got everything you need to make it as versatile and adaptable as you have to be every single day. Choosing Can-Am means choosing to do things your way.

ACCESSORY RECOMMENDATIONS IT'S AN EASY CHOICE.

Whatever you do, and however you want to do it, we've got solutions. And we've made choosing the right accessory easier than ever. Take your pick...



P. 14-17

ACCESSORY COMPATIBILITY GUIDE THE RIGHT FIT.

Be sure to consult our convenient ATV accessory compatibility guides before outfitting your vehicle.



P. 18-19

CARGO BOX OPTIONS

WHO SAYS YOU CAN'T BRING IT WITH YOU?

We've given plenty of room for your stuff with a range of convenient, flexible and durable storage solutions. There's one built for you, and ready to go.



P. 20-25



OUTLANDER

- 18 **COMPATIBILITY GUIDE**
- 20 CARGO
- 26 WINDSHIELDS
- 28 HANDLEBARS & MIRRORS
- 29 RACKS
- 32 SKID PLATES
- 36 BUMPERS
- 38 LIGHTING & ELECTRICAL
- 41 WINCHES
- 43 HITCHES
- 44 PERFORMANCE
- 48 APACHE 360 TRACK SYSTEMS
- 50 PLOWS
- 57 COVERS, DECALS & ADD-ONS
- 171 TIRES
- 174 RIMS



RENEGADE

- 18 **COMPATIBILITY GUIDE**
- 20 CARGO
- 27 WINDSHIELDS
- 28 HANDLEBARS & MIRRORS
- 29 RACKS
- 34 SKID PLATES
- 37 BUMPERS
- 38 LIGHTING & ELECTRICAL
- 41 WINCHES
- 43 HITCHES
- 44 PERFORMANCE
- 48 APACHE 360 TRACK SYSTEMS
- 50 PLOWS
- 57 COVERS, DECALS & ADD-ONS
- 171 TIRES
- 174 RIMS



OUTLANDER 6X6

- 18 **COMPATIBILITY GUIDE**
- 58 APACHE 360 LT TRACK SYSTEM
- 58 HARD TOP
- 59 LOG BARS
- 59 TAILGATE EXTENSION/DIVIDER
- 59 TAILGATE LIMITER KIT
- 60 18 GAL (70L) UTILITY BOX
- 60 FLATBED PROTECTION TUBES
- 60 REAR WINCH KIT
- 61 TARPULIN
- 61 STORAGE COVER
- 61 FULL BODY SKID PLATE
- 171 TIRES
- 174 RIMS

THE CHOICE IS YOURS.



UTILITY

GETTING IT DONE. IT'S IN YOUR BLOOD.



ADVENTURE

ALONE, IT'S A RIDE. WITH FAMILY, IT'S AN ADVENTURE.



TRAIL

IT'S YOUR RIDE. MAKE YOUR PATH.

ACCESSORIES FOR YOUR RIDE.

UTILITY ACCESSORIES

- 1 High Windshield p. 27
- 2 LinQ Base p. 24
LinQ Heavy-Duty Basket p. 25
- 3 5" (13 cm) Rack Extension p. 30
- 4 Multi-Fit Holder p. 31
- 5 Extreme Front Bumper p. 37
- 6 XT Rear Bumper p. 37
- 7 XT Front Bumper p. 37
- 8 Front Bumper Lights p. 40
- 9 Fender Flare p. 45



OUTLANDER
450 / 570

ADVENTURE ACCESSORIES

- 1 Deluxe Fairing p. 26
- 2 High Windshield p. 26
- 3 LinQ 23 Gal (86 L) Trunk Box p. 22
- 4 LinQ 6" (15 cm) Rack Extension p. 29



OUTLANDER

TRAIL ACCESSORIES

- 1 Sport Windshield p. 27
- 2 Handlebar Wind Deflectors p. 28
- 3 LinQ Luggage Rack p. 30
- 4 LinQ 11.5 Gal (43 L) Audio Cargo Box p. 23



RENEGADE

THE CHOICE IS YOURS.

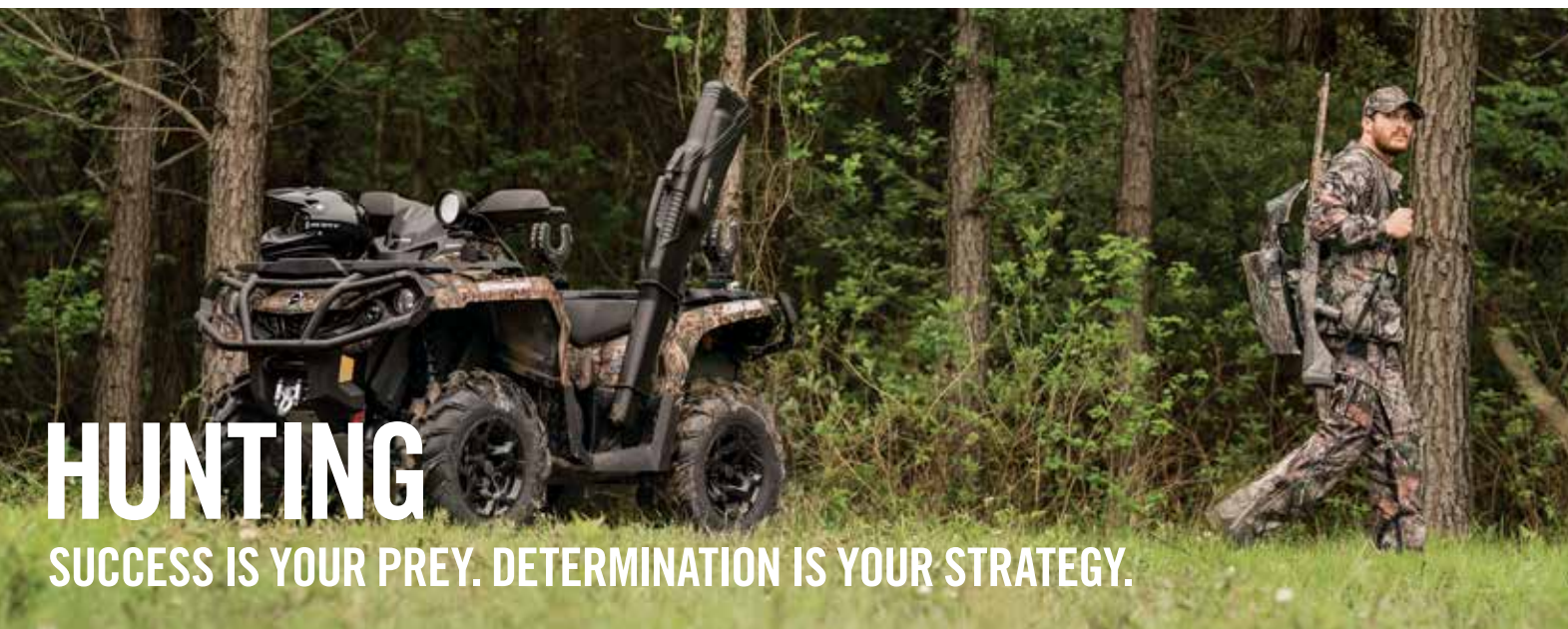

HUNTING

SUCCESS IS YOUR PREY. DETERMINATION IS YOUR STRATEGY.



WINTER

OTHERS HEAD SOUTH. YOU HEAD OUT.



MUD

MUD IS MEAN. YOU'RE MEANER.

ACCESSORIES FOR YOUR RIDE.

HUNTING ACCESSORIES

- 1 Gear Grips by Kolpin p. 31
- 2 LinQ Gun Boot Rack p. 31
Gun Boot 6.0 Impact by Kolpin p. 31
- 3 XT Front Bumper p. 37
- 4 XT Rear Bumper p. 37
- 5 RAM Spotlight p. 40



OUTLANDER

WINTER ACCESSORIES

- 1 LinQ Base p. 24
LinQ Heavy-Duty Basket p. 25
- 2 High Windshield Kit p. 27
- 3 8" (20 cm) Rack Extension p. 30
- 4 XT Rear Bumper p. 37
- 5 60" (152 cm) Alpine Flex Plow Kit p. 51



OUTLANDER
450 / 570

MUD ACCESSORIES

- 1 LinQ Luggage Rack p. 30
- 2 Yoshimura Slip-On Exhaust p. 46
- 3 LinQ 12 Gal (45L) Cargo Box p. 23
- 4 Mud Strap p. 44
- 5 Renegade Snorkel Kit p. 45
- 6 Renegade Extreme Front Bumper p. 37
- 7 Renegade Radiator Relocator Kit p. 45



RENEGADE

ATV ACCESSORY COMPATIBILITY GUIDE

WE'VE MADE THINGS SUPER SIMPLE.

Determine your model year, find your model and engine configuration, and that'll reveal your platform code. This code will let you know at a glance if the accessory is compatible with your vehicle.

EXAMPLE



FULL WRAP ALUMINUM MOUNTING KIT
 • Lightweight black die cast aluminum construction.
 • Includes complete hardware.
 • Handlebar wind deflectors sold separately.

Fits: G2, G2L, G2S
 715001378

	MODEL	ENGINE	PLATFORM
2012	Outlander	400, 500, 650	G1
	Outlander	800, 1000	G2
	Outlander MAX	400, 500, 650, 800	G1
	Renegade	500	G1S
	Renegade	800, 1000	G2S
	DS	70, 90, 250, 450	DS



G1

2013	Outlander	400	G1
	Outlander	500, 650, 800, 1000	G2
	Outlander MAX	400	G1
	Outlander MAX	500, 650, 800, 1000	G2
	Renegade	500, 800, 1000	G2S
	DS	70, 90, 250, 450	DS



G1S

For G1 and DS accessories, refer to your local dealer.

Some products shown may not be available or homologated in your country. Contact your BRP dealer for local details.

	MODEL	ENGINE	PLATFORM
2014	Outlander	400	G1
	Outlander	500, 650, 800, 1000	G2
	Outlander MAX	400	G1
	Outlander MAX	500, 650, 800, 1000	G2
	Renegade	500, 800, 1000	G2S
	DS	70, 90, 250, 450	DS



G2

2015	Outlander L	450,500	G2L
	Outlander	500, 650, 800, 1000	G2
	Outlander L MAX	450, 500	G2L
	Outlander MAX	500, 650, 800, 1000	G2
	6x6	650, 1000	G2
	Renegade	500, 800, 1000	G2S
DS	70, 90, 250, 450	DS	



G2L

2016	Outlander L	450, 570	G2L
	Outlander	570, 650, 850, 1000	G2
	Outlander L MAX	450, 570	G2L
	Outlander MAX	570, 650, 850, 1000	G2
	6x6	650, 1000	G2
	Renegade	570, 850, 1000	G2S
DS	90, 250	DS	



G2S

2017	Outlander	450, 570	G2L
	Outlander	650, 850, 1000	G2
	Outlander MAX	450, 570	G2L
	Outlander MAX	650, 850, 1000	G2
	6x6	650, 1000	G2
	Renegade	570, 850, 1000	G2S
DS	70, 90, 250	DS	



G2

For G1 and DS accessories, refer to your local dealer.



LINQ SYSTEM TRUNK BOXES

LinQ 8 GAL / 30L
715002892 P.22



LinQ 11.5 GAL / 43L
715003018 P.23



LinQ 12 GAL / 45L
715001936 P.23



LinQ 20 GAL / 74L
715002473 P.22



LinQ 23 GAL / 86L
715002474 P.22



LinQ 32 GAL / 124L
715001749 P.21 715001747 P.21
715001750 (EC) 715001748 (EC)



CARGO BOX OPTIONS

CHOOSE THE STORAGE SOLUTION THAT FITS YOU.

When it comes to cargo, we've got a cargo box that suits your needs, your vehicle, and everything you need to bring along for the ride, and in the case of our LinQ 11.5 Gal (43L) Audio Cargo Box, that includes your favorite tunes!

All our cargo boxes are built rugged, and install or remove instantly. They're ideal for work or play, ride after ride after ride.

CATCH THE VIDEO AT CAN-AMOFFROAD.COM

Some products shown may not be available or homologated in your country. Contact your BRP dealer for local details.

OUTLANDER RENEGADE

LinQ 32 GAL (124L) TRUNK BOXES

SEAMLESS INTEGRATION WITH VEHICLE

- Built from the design stage to specifically match your Can-Am vehicle.
- Totally cohesive design eliminates the need to modify your vehicle in any way*.
- Rear tail light.

EASY QUICK-ATTACH INSTALLATION

- Equipped with the LinQ System, the rear trunk box plugs in and out in seconds.
- Instantly transforms your vehicle to suit the need of the moment.

UNPARALLELED STORAGE

- 32 Gal (124L) load capacity with contiguous unobstructed space to maximize storage room and access to the trunk's interior.

BUILD TOUGH

- Made of injection-molded polyethylene, double walled in critical areas.

DUST & WEATHER PROOF

- The fully sealed lid protects your belongings from dust, moisture and the elements.



Ergonomic padding made of closed cell foam.



LinQ 32 GAL (124L) TRUNK BOX

- LinQ Retrofit Adaptor Plate (715001334) is required for G1 models.
- Trunk Box Panels available in many colors to match your vehicle (sold separately).
- LinQ Luggage Rack (715001734) is required for G2S.

Fits: G2 (except MAX models & 6x6), G2S

- 715001747 • Rear tail light included
- 715001748 • No rear tail light (EC Model)



LinQ 32 GAL (124L) TRUNK BOX FOR OUTLANDER MAX

- Passenger comfort is ensured on active rides as well as longer recreational rides thanks to the ergonomically designed passenger padding comfort-fitted with a portion made of closed cell foam that won't absorb water.
- Very easy to embark even when driver is seated.
- Trunk Box Panels available in many colors to match your vehicle (sold separately).

Fits: G2 (MAX models only)

- 715001749 • Rear tail light included
- 715001750 • No rear tail light (EC Model)

LinQ 32 GAL (124L) TRUNK BOX PANELS

- Color panels to match the 32 Gal (124L) LinQ Trunk Box to your vehicle.

Fits: LinQ 32 Gal (124L) Trunk Boxes

- | | |
|------------------------|-------------------------|
| 715001391 - Black | 715002984 - Octane Blue |
| 715001392 - Yellow | 715002985 - Manta Green |
| 715001395 - Viper Red | 715002986 - Can-Am Red |
| 715002481 - White | |
| 715002480 - Light Grey | |

EUROPEAN VERSION (EC compliant)

- No rear tail light
- | | |
|--------------------|------------------------|
| 715001397 - Black | 715002482 - Light Grey |
| 715001398 - Yellow | 715002483 - White |



CAMO DECALS FOR BLACK TRUNK BOX PANELS

- Camo pattern perfectly matches your camo vehicle.

Fits: Black LinQ 32 Gal (124L) Trunk Box Panel

- 715002975 • Mossy Oak Break-Up Country Camo

- 715001683 • Next G-1 Vista Camo



Mossy Oak Break-Up Country



Next G-1 Vista



LinQ REPLACEMENT PART
715001707

* WARNING: You should never accessorize your Can-Am Off-road vehicle with accessories not approved by BRP because your vehicle may no longer meet certain safety and construction standards. This situation could increase the risk of severe injury or death and render your vehicle not legal for use.

NOT SURE IF AN ACCESSORY FITS YOUR MODEL? CHECK OUT OUR ACCESSORY COMPATIBILITY GUIDE ON P.18-19!



OUTLANDER RENEGADE



NEW

LinQ 8 GAL (30L) COOLER BOX

- Rotomolded construction provides exceptional rigidity and durability.
- Premium-quality foam insulation.
- Integrated, fully-removable compartment protects food.
- Weather-resistant, lockable.
- Convenient drain plug.
- Fits on all vehicles using a LinQ rack.
- LinQ Luggage Rack (715001734) is required for G2S.

Fits: G2, G2S

715002892



LinQ 20 GAL (74L) TRUNK BOX

- Installs without vehicle modification.
- LinQ mount for easy-on, easy-off installation.
- Lockable and weather-resistant.
- Holds cargo safely and securely while riding.
- LinQ Base (715002350) is required for G2L.
- LinQ Luggage Rack (715001734) is required for G2S.

Fits: G2 (except MAX & 6x6), G2L (except MAX models), G2S

715002473



LinQ 23 GAL (86L) TRUNK BOX

- Installs without vehicle modification.
- LinQ mounted for easy-on, easy-off installation.
- Lockable and weather-resistant.
- Holds cargo safely and securely while riding.
- Comfort pads for passenger.
- LinQ Base (715002350) is required for G2L.

Fits: G2 (MAX models only except 6x6), G2L (MAX models only)

715002474

Some products shown may not be available or homologated in your country. Contact your BRP dealer for local details.



OUTLANDER RENEGADE

CATCH THE VIDEO AT CAN-AMOFFROAD.COM



MUST HAVE



NEW

LinQ 11.5 GAL (43L) AUDIO CARGO BOX

- Delivers the best sound quality on the market to sweeten your ride courtesy of a built-in full range high efficiency amplifier.
- Mounts on/off easily to hold/carry cargo safely and securely.
- Automatic shut-off function protects your battery by turning the system off after 10 minutes of inactivity.
- The Bluetooth enabled receiver and 6.5" (16.5 cm) speakers are smartly concealed and integrated in the cover.
- Backlit control panel perfect for night riding.
- LinQ Base (715002350) is required for G2L.
- LinQ Luggage Rack (715001734) is required for G2S.

Fits: G2 (front only for 6x6 & MAX models 2013-2014), G2L, G2S

715003018



LinQ 12 GAL (45L) CARGO BOX

- Installs without vehicle modification.
- LinQ mounted for easy-on, easy-off installation.
- Flip-over cover becomes a tray.
- Holds cargo safely and securely while riding.
- LinQ Base (715002350) is required for G2L.
- LinQ Luggage Rack (715001734) is required for G2S.

Fits: G2 (front only for 6x6 & MAX models 2013-2014), G2L, G2S

715001936



LinQ DELUXE MODULAR BAG

- Tool-less installation and removal.
- Versatile, rugged and spacious.
- Ideal for carrying anything you need in any conditions.
- Weatherproof, scratch-resistant, with molded rubber bottom.
- Central compartment can be used alone on the rack.
- Removable bin.
- LinQ Luggage Rack (715001734) is required for G2S.

Fits: G2 (front only for 6x6), G2S

12 Gal (44L) Bag

715001695

20 Gal (73L) Bag

715001694



Removable bin

OUTLANDER RENEGADE

SOFT STORAGE BAG

- 3-section bag.
- Transport gear in a weatherproof bag.
- 6" (15 cm) tall soft cargo bag designed with vehicle's rear or front rack and rack extensions in mind to maximize potential storage.
- LinQ Luggage Rack (715001734) is required for G2S.

Fits: G2, G2L, G2S

715001934 • Black

NEW 715001935

Mossy Oak Break-Up Country Camo



REAR TRUNK BOX 25 GAL (95L)

- Perfect fit with vehicle.
- Made of impact-resistant polyethylene.
- Fully sealed lid.
- Tray quick-hooks to box.
- Molded handle makes lifting and moving the box easy.

Fits: G2, G2S (except X mr)

715001842 • Black

- Equipped with lid key lock.
- Robust double wall lid.
- Improved trunk latch and attachment system on rack.
- Cannot be used with Rear Rack Extensions.
- LinQ Luggage Rack (715001734) is required for G2S.



LinQ STORAGE BOX 2 GAL (7.5L)

- Features easy quick-attach LinQ installation on Outlander front and rear racks.
- Also installable behind the driver seat on Outlander MAX.
- Fully sealed box provides additional storage for essential and valuable items.
- LinQ Luggage Rack (715001734) is required for G2S.

Fits: G2, G2S

708200255

Fits: G2, G2L (Outlander L MAX only behind the driver seat), G2S

708200408

REAR COMPARTMENT STORAGE 2.6 GAL (10L) BAG

- Roll-top dry bag for fully protecting your cargo from the elements.
- Fits in rear compartment of your vehicle.

Fits: G2

269502121



LINQ BASE

(Not illustrated)

- Made of polypropylene glass fiber.
- Allows you to install LinQ accessories.

Fits: G2L

715002350

CARGO BAG

- Rugged all-purpose cargo bag with rain cover for additional protection against the elements.
- LinQ Luggage Rack (715001734) is required for G2S.

Fits: G2, G2L, G2S

280000539 • Black



Rain cover for additional protection



OUTLANDER RENEGADE

[CATCH THE VIDEO AT CAN-AMOFFROAD.COM](https://can-amoffroad.com)



LinQ HEAVY-DUTY BASKET

- Made of high-strength, low-alloy steel.
- Installs without vehicle modification.
- LinQ mount for easy-on, easy-off installation.

Fits: G2, G2L (front only for MAX), G2S

715001215

- Can be placed on both front and back racks of vehicle.
- LinQ Base (715002350) is required for G2L.
- LinQ Luggage Rack (715001734) is required for G2S.



NEW

LinQ LOW PROFILE BASKET

(Not illustrated)

- Low profile, open basket increases cargo space.
- Perfect for easy access to tools, rope, winch and plow accessories.
- Multiple bungee cord and tie-down anchor points.
- Black, impact-resistant injected HDPE.
- LinQ base (715002350) is required for G2L.

Fits: G2L (front only for MAX models)

715003027

RENEGADE

REAR BAG FOR RENEGADE 4.5 GAL (17L)

- Weatherproof, scratch-resistant, with a molded rubber bottom.
- Tool-less installation and removal.
- With 2 straps that go underneath the rack and click into the front of the bag.
- Requires Rear Aluminum Rack (715001360).

Fits: G2S

715002391



OUTLANDER

CREATE YOUR ULTIMATE WIND PROTECTION IN 3 EASY STEPS

01 CHOOSE A DELUXE FAIRING COLOR

DELUXE FAIRING

- Innovative, richly-featured wind protection.
- Quick tool-less removal once base brackets are mounted on handlebar.
- 2 cup holders.
- GPS-mounting-kit-ready.
- Optional mirrors and auxiliary lighting.

- Requires low, high or extra high windshield (715001227, 715001211 or 715000936).
- Tapered Handlebar Adaptor Kit (715002470) is required for vehicles with 1 1/8" (28 mm) tapered aluminum handlebars.



Fits: G2 (except X mr), G2L

- 715000935 - Yellow
- 715001231 - Red

- 715001232 - Black
- 715002479 - Light Grey

CAMO DECALS FOR BLACK DELUXE FAIRING

• Camo pattern perfectly matches your camo vehicle.

Fits: Deluxe Fairing

715002976

Mossy Oak Break-Up Country Camo

715001684

Next G-1 Vista Camo



Mossy Oak Break-Up Country



Next G-1 Vista

TAPERED HANDLEBAR ADAPTOR KIT

- Required to install Deluxe Fairing on a Renegade, on an Outlander X-TP and on any vehicle equipped with 1 1/8" (28 mm) tapered aluminum handlebars.

Fits: Deluxe Fairing

715002470

02 CHOOSE A DELUXE WINDSHIELD



LOW WINDSHIELD

- 6" (15 cm) windshield allows you to keep your vehicle looking sporty while giving you some protection from the elements and the possibility of enjoying directional lighting.
- Tool-less installation and replacement.

Fits: Deluxe Fairing

715001227



HIGH WINDSHIELD

- 11" (28 cm) high, for wind protection and winter applications.
- Tool-less installation and replacement.

Fits: Deluxe Fairing

715001211

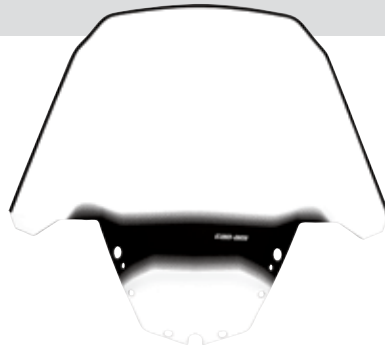

EXTRA HIGH WINDSHIELD

- 16" (41 cm) windshield provides the ultimate protection against the elements while touring.
- For wind protection and winter applications.
- Tool-less installation and replacement.

Fits: Deluxe Fairing

715000936

03 YOU MIGHT ALSO LIKE...

AUXILIARY WINDSHIELD LIGHTING

- 2 premium LED spots for Deluxe Fairing for both increased output and directional lighting.

Fits: Deluxe Fairing

715001214



DELUXE MIRROR KIT

- Improved mounting system.
- Wide rear view.
- Perfect fit with your Deluxe Fairing and Deluxe Windshield.

Fits: Deluxe Fairing

715002353



OUTLANDER RENEGADE

HIGH WINDSHIELD KIT

- Provides excellent wind protection.
- Fits straight and tapered handlebars.
- Easy mounting system allows you to install it effortlessly.

Fits: G2, G2L, G2S

- 715001937 - Yellow
- 715001938 - Black
- 715002061 - Red



SPORT WINDSHIELD

- Offers your Renegade wind protection without compromising its sporty look.
- Fits straight and tapered handlebars.
- Easy mounting system allows you to install it effortlessly.

Fits: G2S

- 715001212 - Yellow
- 715001429 - White
- 715001468 - Black



Some products shown may not be available or homologated in your country. Contact your BRP dealer for local details.

OUTLANDER RENEGADE



HANDLEBAR WIND DEFLECTORS

- Rugged injected plastic construction with Can-Am logo.
- Include removable cap for air flow adjustment.
- Mounting kit sold separately (715001378, 715001379).

Fits: G2, G2L, G2S

- 715000525 • Black / Yellow
- 715000537 • White / Black
- 715001706 • Black / Black
- 715000733 • Yellow / Black

- 715003811 • Can-Am Red / Black
- 715003812 • Manta Green / Black
- 715003813 • Orange / Black
- 715003814 • Octane Blue / Black



PASSENGER WIND DEFLECTORS

- These wind deflectors fit on the passenger handles and provide greater comfort while riding.
- Easy to install and remove.

Fits: G2 & G2L (MAX models only)

715001669

FULL WRAP ALUMINUM MOUNTING KIT

- Lightweight black die cast aluminum construction.
- Includes complete hardware.
- Handlebar wind deflectors sold separately.

Fits: G2, G2L, G2S

715001378



SHORT ALUMINUM MOUNTING KIT

- Lightweight black die cast aluminum construction.
- Includes complete hardware.
- Handlebar wind deflectors sold separately.

Fits: G2, G2L, G2S

715001379



ALUMINUM TAPERED HANDLEBAR

- 7/8" - 1 1/8" (22 mm - 28 mm) tapered handlebar made of 6061-T6 aluminum.
- Includes all hardware, center steering foam and cover.

Fits: G2, G2L, G2S

715000550



MIRROR KIT FOR HANDLEBAR WIND DEFLECTORS

- Do not fit with Full Wrap Aluminum Mounting Kit (715001378).
- Sold in pairs.

Fits: Handlebar Wind Deflectors

860200080



XT HANDLEBAR PROTECTOR KIT

- Not compatible with Mud Strap (715003053).

Fits: G2, G2L

703100352 • Black

MIRRORS

- True vision surface 5" x 3" (13 cm x 8 cm).
- Matte finish.
- Stem includes 3/8" (10 mm) thread.

Left - 3/8" (10 mm)

- Bracket (715000190) is required for installation on DS 450.
- Bracket not required for installation on Outlander and Renegade.

709400406

Right - 3/8" (10 mm)

- Bracket (715000190) required except for vehicles with right hand break.

709400523



OUTLANDER RENEGADE



LinQ 4" (10 CM) RACK EXTENSION

- Fits front or rear.
- Strong and durable.
- Helps keep cargo securely in place.
- Easy and tool-less installation thanks to the LinQ System.

Fits: G2, G2S

- 715001711 • Silver
- 715001665 • Black

- Anti-corrosion coating with durable powder coat finish.
- LinQ Luggage Rack (715001734) is required for G2S.



LinQ 6" (15 CM) RACK EXTENSION

- Fits front or rear.
- Strong and durable.
- Helps keep cargo securely in place.
- Easy and tool-less installation thanks to the LinQ System.

Fits: G2, G2S

- 715001712 • Silver
- 715001671 • Black

- Anti-corrosion coating with durable powder coat finish.
- LinQ Luggage Rack (715001734) is required for G2S.

 **CATCH THE VIDEO AT CAN-AMOFFROAD.COM**



OUTLANDER

5" (13 CM) RACK EXTENSION

- Fits front or rear.
- Made of carbon steel.
- Provides tie-down points to secure cargo on racks.
- Easy installation on tubular rack.
- Anti-corrosion coating with durable powder coat finish.

Fits: G2L
715001913



8" (20 CM) RACK EXTENSION

- Fits front or rear.
- Made of carbon steel.
- Provides tie-down points to secure cargo on racks.
- Easy installation on tubular rack.
- Anti-corrosion coating with durable powder coat finish.

Fits: G2L
715001914



RENEGADE



LinQ LUGGAGE RACK

- Bolt-on rack.
- Enables use of LinQ mounted accessories on the G2S.

Fits: G2S (except X mr models)
715001734



REAR ALUMINUM RACK

- 30 lb (14 kg) capacity.
- Compact, lightweight aluminum construction.
- Engraved Can-Am logo.
- Stamped 5052 aluminum center plate.
- Easy to install.

Fits: G2S
715001360



OUTLANDER



LinQ GUN BOOT RACK

(Not illustrated)

- This lightweight Gun Boot Rack can be mounted on either side of your Outlander using the tool-less LinQ System.
- For use with Gun Boot 6.0 Impact by Kolpin (715001419).

Fits: G2 (except MAX & 6x6 models)
715002112 • Black

Fits: G2 (MAX models only)
715002113 • Black



715001919

GUN BOOT RACK

- Made of steel.
- Designed for the tubular rack.
- For use with Gun Boot 6.0 Impact by Kolpin (715001419).
- Can be mounted to either side of the vehicle.

Fits: G2L (except MAX models)
715001918

Fits: G2L (MAX models only)
715001919



GUN BOOT 6.0 IMPACT[†] BY KOLPIN[†]

- Extra room for pistol-grip-type weapons and small bipods.
- Easily fits firearms up to 51" (130 cm) in total length.
- Provides ample room for 2 3/8" (60 mm) scopes.
- Hatchback design allows easy access.
- Ergonomically designed handle and molded attachment points for sling.
- Snap-close cover with locking capability.

715001419

- Designed to accommodate left and right hand bolt-action rifles and shotguns.
- Includes removable, shock absorbing foam and nylon impact liner for superior interior protection.
- Requires appropriate mounting kit for installation (715002112, 715002113, 715001918 or 715001919).

MULTI-FIT HOLDER

- Open u-shaped bracket for carrying tools (shovel, axe) and hunting weapons (rifle, bow) that are safely secured, but easily accessible.
- Easy installation on tubular rack, extension racks, basket or bumpers.
- Sold in pairs.

Fits: G2, G2L
Single
715002354

Fits: G2, G2L
Double
715001945



OUTLANDER RENEGADE



LinQ MOUNTED GEAR GRIPS BY KOLPIN

(Not illustrated)

- Same features as Gear Grip by Kolpin (715001421).
- Make transporting your tools a snap by combining the Gear Grips with the LinQ System.
- 360° orientation.
- LinQ Luggage Rack (715001734) is required for G2S.

Fits: G2, G2S
715001351



GEAR GRIPS BY KOLPIN

- Durable, flexible grips cushion and protect while providing a custom fit for a variety of items from 1" to 4" (2.5 cm to 10 cm) in diameter.
- Heavy-duty design for carrying bows, fishing poles, rakes, farm tools and more.
- Quick-release button opens grip quickly for easy access to gear.
- Heavy-duty base system built for the toughest adventures.
- Sold in pairs.
- Easy installation on tubular racks, extension racks, brackets or bumpers.

Fits: G2L
715001421



LinQ TOOL HOLDER

- Ultra-versatile tool holder.
- Convenient swivel-latch allows tools to be stored in any orientation.
- LinQ Luggage Rack (715001734) is required for G2S.
- Sold in pairs.

Fits: G2, G2S
715003059



OUTLANDER

ALUMINUM SKID PLATES

Our Aluminum Plates are made with high strength 5052 H32 aluminum. A must-have for rugged terrain.



Some products shown may not be available or homologated in your country. Contact your BRP dealer for local details.

FIND YOUR PLATFORM

G2 (EXCEPT MAX MODELS)	G2 (MAX MODELS & OUTLANDER X MR 1000 ONLY)	G2L (EXCEPT MAX MODELS)	G2L (MAX MODELS ONLY)	G2 (6X6 ONLY)
---------------------------	--	----------------------------	--------------------------	------------------

ALUMINUM SKID PLATE PROTECTION KIT

INCLUDES:	• Front Skid Plate • Rear Differential Protectors	• A-Arm Protectors • Rear Skid Plate	• Central Skid Plate • Trailing Arm Protectors (not included for Outlander L and Outlander L MAX)	• Footwell Protector Plates
715002137*	715002138*	715002299	715002300	

* Fits: 2016 & prior models

INDIVIDUAL ALUMINUM SKID PLATES

A-ARM PROTECTORS

• 1/8" (3 mm) thick lightweight and durable design. • Add more protection to the CV joints and rubber boots. • Drain holes to release water, mud and debris.	• Easy to install. • Replace stock plastic protectors. • Can-Am logo.	• Sold in pairs. • Except X mr		
715001667	715001667	715001667	715001667	715001667

FRONT SKID PLATE

• 3/16" (4.5 mm) thick and die-formed for strength and durability.	• Use in conjunction with the central skid plate for full frame protection.			
715000926	715000926	715001906	715001906	

CENTRAL SKID PLATE

• 3/16" (4.5 mm) thick for durability and strength. • Drain holes to release water, mud and debris.	• Allows access to oil drain plug. • Can-Am Logo.	• Must be installed with front skid plate.		
715002078	715002078	715002078	715002078	

FOOTWELL PROTECTOR PLATES

• 1/8" (3 mm) thick lightweight and durable design. • Use in conjunction with the central skid plate.	• Drain holes to release water, mud and debris. • Sold in pairs.			
715000922	715000922	715000922	715000922	

TRAILING ARM PROTECTORS

• 1/8" (3 mm) thick lightweight and durable design. • Replace stock plastic protectors.	• Can-Am logo. • Sold in pairs.	• Fits: G2 2016 & prior.		
715001129	715001129			715001129

REAR DIFFERENTIAL PROTECTORS

• 1/8" (3 mm) thick lightweight and durable design.	• Replace stock plastic protector.			
715000920	715000920	715000920	715000920	

REAR SKID PLATE

• 3/16" (4.5 mm) thick for durability and strength.	• Must be installed with the central and front skid plates.			
715002028	715002029	715002028	715002029	

Some models and accessories shown may not be available or homologated in your country. Contact your BRP dealer or local authorities for more information.

RENEGADE

ALUMINUM SKID PLATES

Our Aluminum Plates are made with high strength 5052 H32 aluminum. A must-have for rugged terrain.



G2S

ALUMINUM SKID PLATE PROTECTION KIT

INCLUDES:		
- Front Skid Plate	- A-Arm Protectors	715002139
- Central Skid Plate	- Footwell Protector Plates	
- Rear Differential Protectors	- Rear Skid Plate	
- Trailing Arm Protectors	- Fits: 2016 & prior	

INDIVIDUAL ALUMINUM SKID PLATES

A-ARM PROTECTORS

- 1/8" (3 mm) thick lightweight and durable design.	- Easy to install.	715001667
- Add more protection to the CV joints and rubber boots.	- Replace stock plastic protectors.	
- Drain holes to release water, mud and debris.	- Can-Am logo.	
	- Sold in pairs.	

FRONT SKID PLATE

- 3/16" (4.5 mm) thick and die-formed for strength and durability.	- Can-Am logo.	715000925
- Recessed bolt holes.		

CENTRAL SKID PLATE

- 3/16" (4.5 mm) thick for durability and strength.	- Can-Am logo.	715002078
- Drain holes to release water, mud and debris.	- Standard on Renegade X xc.	
- Allows access to oil drain plug.	- Must be installed with Front Skid Plate.	

FOOTWELL PROTECTOR PLATES

- 1/8" (3 mm) thick lightweight and durable design.	- Use in conjunction with Central Skid Plate.	715001359
- Drain holes to release water, mud and debris.	- Sold in pairs.	

TRAILING ARM PROTECTORS

- 1/8" (3 mm) thick lightweight and durable design.	- Can-Am logo.	715001129
- Replace stock plastic protectors.	- Sold in pairs.	
	- Fits: G2S 2016 & prior.	

REAR DIFFERENTIAL PROTECTORS

- 1/8" (3 mm) thick lightweight and durable design.	- Replace stock plastic protector.	715000920

REAR SKID PLATE

- 3/16" (4.5 mm) thick for durability and strength.	- Must be installed with the central and front skid plates.	715002028
---	---	-----------

Some products shown may not be available or homologated in your country. Contact your BRP dealer for local details.

OUTLANDER RENEGADE

HMWPE SKID PLATES

Our Plastic Plates glide smoothly and silently over obstacles, offering great protection in rough terrain. Made of 1/4" (6 mm) thick abrasion-resistant thermoformed High Molecular Weight Polyethylene (HMWPE). Lighter than aluminum. Cold cracking resistant. High impact energy absorption.

CATCH THE VIDEO AT CAN-AMOFFROAD.COM

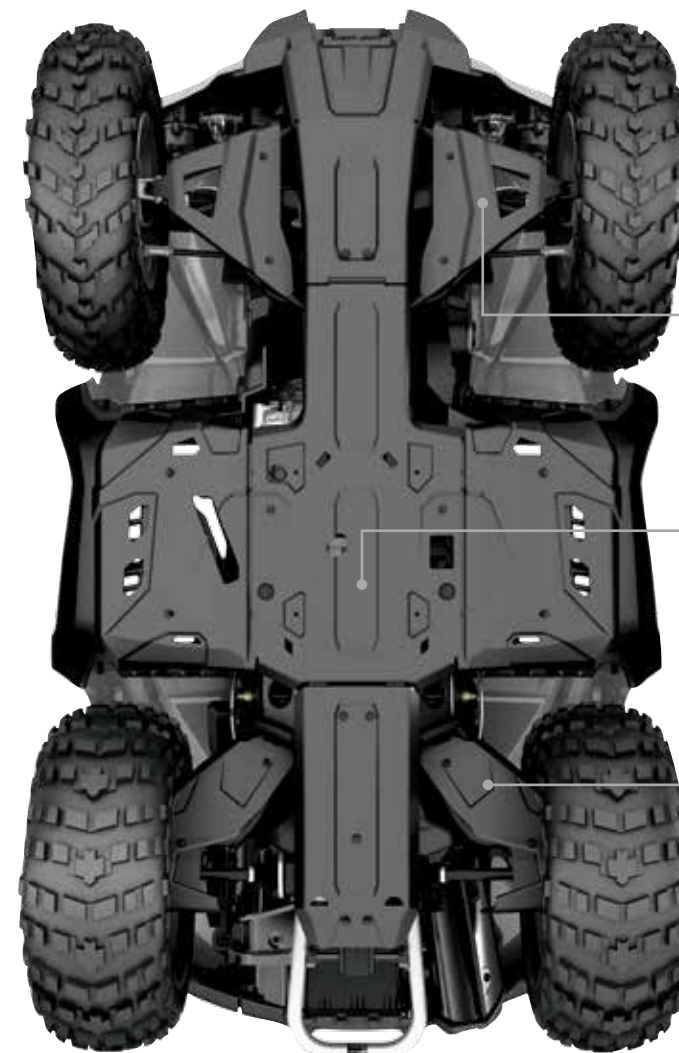

FIND YOUR PLATFORM

G2 2017	G2 2016 & PRIOR	G2 MAX 2017	G2 MAX 2016 & PRIOR	G2L	G2L MAX	G2S 2017
------------	-----------------------	----------------	---------------------------	-----	---------	-------------

HMWPE PLASTIC SKID PLATE PROTECTION KIT

INCLUDES:	- A-Arm Protectors	- Underbelly plates	- Trailing Arm Protectors
NEW 715004209	NEW 715004214	NEW 715004210	NEW 715004215
NEW 715004211	NEW 715004212	NEW 715004213	

INDIVIDUAL HMWPE PLASTIC SKID PLATES

A-ARM PROTECTORS

- Protect CV joints and rubber boots.	- Include water and mud drainage holes.	- Can-Am logo.	- Sold in pairs.
---------------------------------------	---	----------------	------------------

715002924	715002924	715002924	715002924	715002924	715002924	715002924
-----------	-----------	-----------	-----------	-----------	-----------	-----------

UNDERBELLY PLATES

- Includes Front Skid Plate, Central Skid Plate, Footwell Protector Plates and Rear Skid Plate.	- Allow access to oil drain plug.	- Include water and mud drainage holes.	- Can-Am logo.
---	-----------------------------------	---	----------------

715002926	715002926	715002927	715002927	NEW 715002928	NEW 715002929	NEW 715002974
-----------	-----------	-----------	-----------	-------------------------	-------------------------	-------------------------

TRAILING ARM PROTECTORS

- Include water and mud drainage holes.	- Sold in pairs.
---	------------------

NEW 715003466	715002925	NEW 715003466	715002925	NEW 715003466	NEW 715003466	NEW 715003466
-------------------------	-----------	-------------------------	-----------	-------------------------	-------------------------	-------------------------

PLASTIC SKID PLATES

FRONT AND CENTRAL PLASTIC SKID PLATES

(Not illustrated)
 - Designed to protect frame and engine from rough terrain conditions.
 - Standard on Outlander L DPS® and Outlander L MAX DPS.

Fits: G2L (STD only)
 715002374



OUTLANDER

NEW

COMPLETE RANCHER PROTECTION KIT

- (Not illustrated)
- Introducing a whole new level of surround protection for your ATV thanks to this Full Body Protection Kit that includes a Rancher Front Bumper (715003461), Rancher Rear Bumper (715003462), and Body Side Protector (715003459).
- Requires Body Side Protector Extensions (715003460) for installation on MAX models.

Fits: G2, G2L
715003463

CATCH THE VIDEO AT CAN-AMOFFROAD.COM

NEW

BODY SIDE PROTECTOR EXTENSIONS

- (Not illustrated)
- This specially designed extension for Body Side Protector (715003459 or 715003614) is made specifically to fit and seamlessly integrate the look of Outlander MAX models.

Fits: G2, G2L (MAX models only)
715003460

OUTLANDER



XT FRONT BUMPER

- Provides additional protection against the elements.
- Tough and durable, can be added on base Outlander model to convert vehicle into XT model.
- Large tube construction with textured black finish.
- Standard on XT model.

Fits: G2
715000947



XT FRONT BUMPER

- Large tube construction.
- Protects vehicle frame against obstacles.
- Winch compatible.

Fits: G2L
715001910



EXTREME FRONT BUMPER

- Ultra-sturdy build.
- Enhances front-vehicle protection.
- Compatible with XT Front Bumper.
- Fits the Apache 360 Track System (when side panels are removed).

Fits: G2
715001286



EXTREME FRONT BUMPER

- Ultra-sturdy build.
- Enhances front-vehicle protection.
- Compatible with XT Front Bumper.
- Fits the Apache 360 Track System (when side panels are removed).

Fits: G2L
715004279



NEW

RANCHER REAR BUMPER

- The heavy-duty bumper designed to pull double duty: protect your ATV and anything it comes in contact with, while also enhancing the look of your ATV.
- Made tough and designed to deliver a rugged appearance, this bumper offers rear protection for farmer, rancher and forestry applications.
- Ideal for using your ATV within cattle herds and guard the safety of both the vehicle and the animals.
- Coverage extends to provide an extra layer of defense to your tail lights.
- Inside and outside anti-corrosion coating with durable powder coat finish.
- Not compatible with track systems.

Fits: G2, G2L
715003462



NEW

BODY SIDE PROTECTOR

- The heavy-duty fender guard designed to pull double duty: protect your ATV and also enhance the look of your ATV.
- Made tough and designed to deliver a rugged appearance, this fender guard offers full side protection for farmer, rancher and forestry applications.
- Built of durably bold 1.25" (3 cm) diameter steel-tube construction, with inside and outside anti-corrosion coating with durable powder coat finish.
- XT Front Bumper, XT Rear Bumper, Rancher Front Bumper or Rancher Rear Bumper required for installation.
- Sold in pairs.

Fits: G2 with XT or Rancher Bumpers, G2L with Rancher Bumpers

- Requires Body Side Protector Extensions (715003460) for installation on MAX models.

715003459

Fits: G2L with XT Bumpers
715003614



NEW

RANCHER FRONT BUMPER

- The heavy-duty bumper designed to pull double duty: protect your ATV and anything it comes in contact with, while also enhancing the look of your ATV.
- Made tough and designed to deliver a rugged appearance, this bumper offers front protection for farmer, rancher and forestry applications.
- The low front end protection and plates allow you to use your ATV within cattle herds and guard the safety of both the vehicle and the animals.
- The flat front portion facilitates gently prodding cattle or pushing light objects, e.g. closing a fence.
- The full frontage coverage extends to provide an extra layer of defense to your headlights and radiator.
- Inside and outside anti-corrosion coating with durable powder coat finish.
- Not compatible with track systems and plows.

Fits: G2, G2L
715003461



XT REAR BUMPER

- Provides additional protection against the elements.
- Tough and durable, can be added on base Outlander model to convert vehicle into XT model.
- Large tube construction with textured black finish.
- Standard on XT model.

Fits: G2
715000948



XT REAR BUMPER

- Large tube construction.
- Protects vehicle frame against the obstacles.

Fits: G2L
715001911

RENEGADE

RENEGADE EXTREME FRONT BUMPER

- Enhanced vehicle front protection.
- Required as a mounting point for Radiator Relocator (715001929).

Fits: G2S
715002469





OUTLANDER RENEGADE



NEW

LinQ 11.5 GAL (43L) AUDIO CARGO BOX

- Delivers the best sound quality on the market to sweeten your ride courtesy of a built-in full range high efficiency amplifier.
- Mounts on/off easily to hold/carry cargo safely and securely.
- The Bluetooth enabled receiver and 6.5" speakers are smartly concealed and integrated in the cover.
- Automatic shut-off function protects your battery by turning the system off after 10 minutes of inactivity.
- Backlit control panel perfect for night riding.
- LinQ Base (715002350) is required for G2L.
- LinQ Luggage Rack (715001734) is required for G2S.

Fits: G2 (front only for 6x6 & MAX models 2013-2014), G2L, G2S 715003018



MUST HAVE

CATCH THE VIDEO AT CAN-AMOFFROAD.COM

OUTLANDER RENEGADE

HEATED HAND GRIPS & THROTTLE COMBO

Fits: G2, G2L (Wiring Cable (710004567) required for installation), G2S 715001849

NEW 715003250

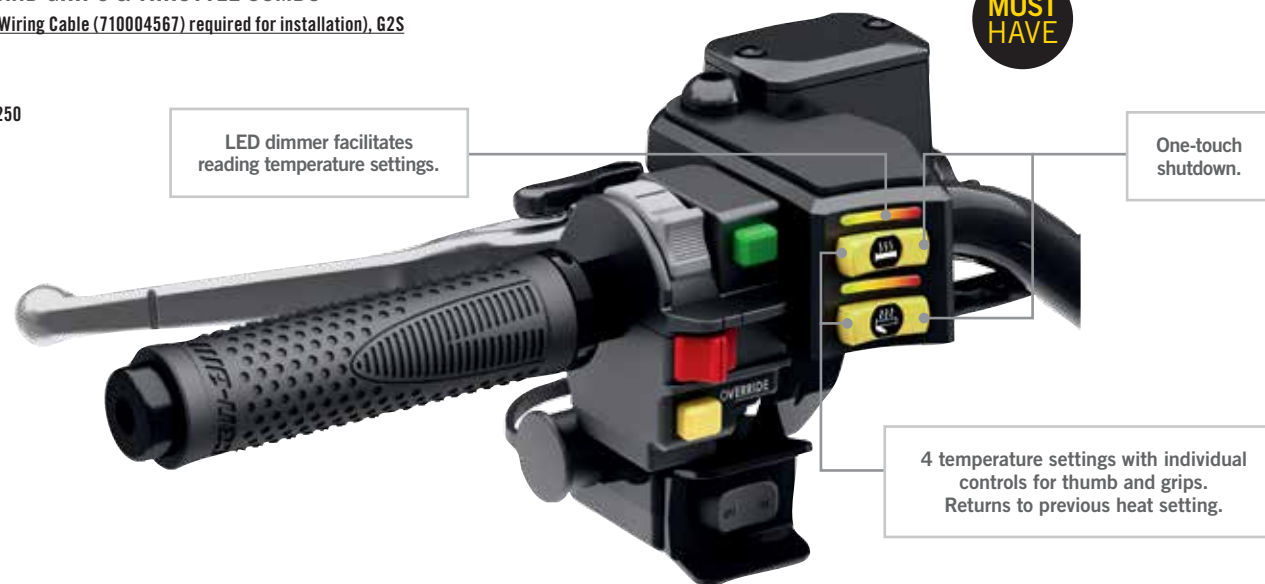

MUST HAVE

OUTLANDER

HEATED PASSENGER GRIPS & VISOR OUTLET

- Replace your stock passenger handles.
- Dual temperature switch integrated into seat arm for 3-zone heated handles and grips.
- Heated visor outlet integrated into seat arm.

Fits: G2, G2L (MAX models only) 715001926

Fits: G2 (2013-2014) (MAX models only) 715002116



THERE'S MUCH MORE TO SEE – CHECK OUT THE CYCLOPS 360 ON PAGE 184

CGX2 CAMERA

- 4K HD and 1080p at 60fps.
 - 2" LCD display screen.
 - Waterproof housing of up to 165 ft (50 m) underwater and the 2.4gh waterproof remote.
 - Comes with 32gb micro SD card class 10 and 9 mounts.
 - WIFI available to control your camera from your smart phone or tablet with the free iCyclops App for IOS and Android.
- 2866860090**

HEATED VISOR OUTLET

- Strategically positioned on vehicle to maintain your agility.
- Optional visor outlet that delivers fog-free riding.
- Quick and easy installation.
- Sold individually.
- Heated Visor not included.

Fits: G2, G2L 715001246



WIRING CABLE

- Required for installation of Heated Hand Grips & Throttle Combo (715001849).

Fits: G2L 710004567



DPS MODULE

(Not illustrated)
Fits: G2L (except base models), G2 (except base models) 715001202

OUTLANDER RENEGADE

FRONT BUMPER LIGHTS

- 2 x 900 lumens 10W LED Cree light kit.
- Long-range illumination up to 350' (107 m), drawing less than 1 amp per light.
- Include multi-position clamps that fit on various tubing sizes.
- Not EC compliant.

Fits: G2, G2L
715001741



AUXILIARY WINDSHIELD LIGHTING

- 2 premium LED spots for Deluxe Fairing for both increased output and directional lighting.
- 1,800 lumens.
- 2 10W LED Cree light kit.
- Long-range illumination up to 350' (107 m), drawing less than 1 amp per light.

Fits: Deluxe fairing
715001214



NEW

RAM LED SPOTLIGHT

- 540 lumens LED light (9 Watt) heavy-duty spotlight standard-equipped with 1" (2.5 cm) diameter rubber-coated double ball and socket system.

710005423 • Black



CENTER CONSOLE DAY LIGHT

- Mountable on top end of center console.
- Enhances look of vehicle.

Fits: G2S
715000691



OUTLANDER

CAN-AM TERRA BY SUPERWINCH†

- Heavy-duty 4-way roller fairlead.
- Ergonomic clutch handle.
- Rugged all-steel gears and bushings, provides more torque and longer life.
- 100% mechanical load holding brake and electronic dynamic brake.

- Sealed solenoid for all weather protection.
- Corded 10' (3m) weather sealed hand-held remote.
- Weather sealed handlebar mounted switch.
- EC Compliant.



CAN-AM TERRA 35 WINCH BY SUPERWINCH

- Pulling strength capability of 3,500 lb (1,588 kg).
- 50 ft. of 13/64" (15.2 m of 5.2 mm) wire steel cable.

Fits: G2, G2L
715003476



CAN-AM TERRA 25 WINCH BY SUPERWINCH

- Pulling strength capability of 2,500 lb (1,134 kg).
- 50 ft. of 3/16" (15.2 m of 4.8 mm) wire steel cable.

Fits: G2, G2L
715003475

OUTLANDER RENEGADE

WARN† PROVANTAGE

- Patented roller disc brake for outstanding control while winching.
- Ergonomic clutch handle.
- Three-stage planetary gear train for smooth, efficient operation.
- All-metal gear housing and gears.
- Fully sealed motor and drive train to keep the elements out.
- Corded remote and mini-rocker control switch with integrated socket.

- Limited lifetime warranty for mechanical components and 3-year warranty for electrical components.
- Winch mounting plate (715000927) is required for G2S.
- Winch wire harness (715002453) is required for G2L.
- EC Compliant.



WARN PROVANTAGE 3500-S WINCH

- Double powder coated hawse fairlead.
- Pulling strength capability of 3,500 lb (1,588 kg).
- 50 ft. of 3/16" (15.2 m of 4.8 mm) synthetic rope.

Fits: G2, G2L, G2S
715003473



WARN PROVANTAGE 3000 WINCH

- Roller fairlead.
- Pulling strength capability of 3,000 lb (1,361 kg).
- 50 ft. of 3/16" (15.2 m of 4.8 mm) wire steel cable.

Fits: G2, G2L, G2S
715003474



WARN PROVANTAGE 2500-S WINCH

- Double powder coated hawse fairlead.
- Pulling strength capability of 2,500 lb (1,134 kg).
- 50 ft. of 3/16" (15.2 m of 4.8 mm) synthetic rope.

Fits: G2, G2L, G2S
715003472



NEW

GARMIN† MONTANA† 680T GPS

- Rugged and waterproof, the Montana 680T is element-proof.
- 4-inch dual-orientation, sunlight-readable touchscreen and glove-friendly touchscreen display, to give you vivid colors and high-resolution images.
- 8-megapixel autofocus camera automatically geotags photos.
- Tracks both GPS and GLONASS satellites for improved positioning and typically faster fixes.
- Preloaded TOPO maps, plus 1-year BirdsEye Satellite Imagery subscription.
- 3-axis compass with barometric altimeter.
- Specific GPS cradle included (vehicle mounting kit required).
- Includes a preloaded map for US.

Fits: G2, G2L, G2S
715002830

EUROPEAN VERSION

- EC compliant.
 - Includes preloaded European recreation map.
- 715003456

NEW

CANADIAN MAP FOR GARMIN MONTANA 680T GPS

- Additional and readily-programmable Canadian basemap for Garmin Montana 680T GPS system.
- Requires Garmin Montana 680T GPS (715002830).

710005065



GPS RAM® MOUNT FOR HANDLEBAR

- Convenient bracket for installing the Garmin Montana GPS (not included) onto your unit's handlebar.

Fits: G2, G2L, G2S
715001985

Some products shown may not be available or homologated in your country. Contact your BRP dealer for local details.

OUTLANDER RENEGADE

WINCH MOUNTING PLATE

- Adds functionality to your Renegade.
- Fits Can-Am winches by Warn.

Fits: G2S

715000927



WIRELESS REMOTE CONTROL

- The system is quick and easy to install, thanks to a wiring harness with an integrated antenna and all necessary mounting hardware.
- The system allows you to operate your winch from anywhere within a 50' (15.2 m) radius, increasing your recovery options.
- All components are weatherproof.

Fits: Warn winches

715002542



WIRED REMOTE CONTROL

- This kit allows winch owners to add the hand-held remote to their winch.
- Works in conjunction with the mini-rocker switch.

Fits: 2016 models & prior

710002270

Fits: G2, G2S, G2L

- Remote socket (715003651) is required.

710001002



WARN REMOTE SOCKET

(Not illustrated)

715003651

WINCH WIRE HARNESS

(Not illustrated)

- Required plug-and-go wiring to install Warn winch only.
- Not required for Can-Am Terra winch.

Fits: G2L

715002453

HARDWARE ADAPTER KIT

(Not illustrated)

- Required to install Warn Winch Kit (715002500, 715002561, 715002499) on 2016 & up models.
- Required to install Can-Am Terra 25 Winch (715002167) and Can-Am Terra 35 Winch (715002057) on G2L 2017 & up models.

715003477

WINCH ACCESSORIES KIT

- Get the most out of your winch.
- Double your pulling power, change your pulling direction and keep your winch in proper working order.
- Includes tree straps, snatch block, shackle and winching gloves.

715002409



SYNTHETIC WINCH CABLE

- Easier to manipulate than steel cable.
- Replaces the original cable on any factory installed Warn winch or sold as an accessory by BRP.
- Kit includes synthetic rope and rock guard sleeve.
- Always use with new Roller Fairlead (715000011) to prevent premature wear.

50' (15.2 m), 3,500 lb (1,588 kg) pulling strength

715000539



REPLACEMENT WIRE ROPE

- Play it safe, always carry a replacement wire rope.
- 50' (15.2 m) aircraft grade steel wire.
- 3/16" (4.8 mm) diameter.
- 3,500 lb (1,588 kg) pulling strength.

Fits: All Warn winches

715000047



ROLLER FAIRLEAD

- Features top, bottom and side rollers for less cable wear and smoother operation from any direction for easier winching.

715000011



HOOK WITH SAFETY LATCH & STRAP KIT

- Heavy-duty winch-rope hook with stainless steel snap.
- Includes a nylon safety strap.

715000069



OUTLANDER



FRONT HITCH

- Front hitch for Outlander with or without a winch.
- This hitch offers 1,300 lb (590 kg) of towing capacity.
- Allows you to maneuver your trailer easily in tight, confined areas.
- Hitch bar sold separately.

Fits: G2

715000921

REAR RECEIVER HITCH

- E-coat finish.
- Does not affect ground clearance.
- Trailer ball not included.
- This hitch offers 1,300 lb (590 kg) of towing capacity.

Fits: G2L, G2S

715001329



OUTLANDER RENEGADE



FRONT & REAR HITCH DRAWBAR

- Fits 2" (5 cm) receiver hitch that comes standard on Outlanders.
- Hitch ball not included.
- This hitch offers 1,300 lb (590 kg) of towing capacity.

Fits: G2, G2L, G2S

715000972

EUROPEAN VERSION

715001473 • Drawbar with 50mm European ball



REAR RECEIVER HITCH

- E-coat finish.
- Fixed hitch ball mounting bracket.
- Provides fixed mounting point for trailer ball to provide vehicle with towing capabilities.
- This hitch offers 1,300 lb (590 kg) of towing capacity.

Fits: G2, G2L, G2S

715001925



RUBBER RECEIVER PLUG

- Rubber cap for 2" (5 cm) hitch receiver.

705204503





OUTLANDER



OUTLANDER RADIATOR RELOCATOR KIT

- Relocates radiator to top mount position.
- Prevents cooling performance loss in muddy conditions.
- Uses existing radiator.
- Includes support, hardware and hoses.
- Engineered for easy cooling system bleeding and maintenance.
- Radiator not included.

Fits: G2, G2L
715001930 • Black



OUTLANDER SNORKEL KIT

- Comprehensive kit.
- Extended air intakes and CVT exhaust.
- CVT Outlet integrates into pod cover.
- Ideal for muddy conditions.
- Must be installed on a vehicle without XT handlebar protector kit.
- For 6x6, appropriate gauge support is required for best fit and finish.

Fits: G2, G2L **Fits: G2 (X mr models only), G2L (X mr models only)** **Fits: G2 (2012-2014 only)**
715002392 715002518 715001730



X MR TRACTION PLATES

- Provide extra foot grip for driver when riding in extreme mud conditions.
- Help driver to maintain ideal riding position to maximize vehicle traction.
- Made of aluminum.
- Not meant for a passenger.

Fits: G2, G2L (MAX models only)
715001752 • Aluminum



FOOTPEG KIT

- Provides maximum integrated grip and more stability during vigorous riding.
- Kick-up end generates added grip during hard cornering.
- Made of aluminum.
- Sold in pairs.

Fits: G2, G2L
715001131

OUTLANDER RENEGADE



MUD STRAP

- Convenient sturdy grab-handle.
- Lets drivers redistribute their weight for improved traction in demanding conditions.
- Not compatible with XT Handlebar Protector Kit (703100352).

Fits: G2, G2L, G2S
715003053

RENEGADE



RENEGADE SNORKEL KIT

- Comprehensive kit.
- Extended air intakes and CVT exhaust.
- CVT Outlet integrates into pod cover.
- Ideal for muddy conditions.

Fits: G2S
715001928

ADAPTOR KIT

- (Not illustrated)
- Necessary to install the G2S Snorkel Kit (715001928) on 2012 to 2014 models.

Fits: G2S (for 2012-2014 models only)
715003122



RENEGADE RADIATOR RELOCATOR KIT

- Relocates radiator to top mount position.
- Prevents cooling performance loss in muddy conditions.
- Uses existing radiator.
- Includes support, hardware and hoses.
- Engineered for easy cooling system bleeding and maintenance.
- Radiator not included.
- Renegade Extreme Front Bumper (715002469) required for installation (except X mr).

Fits: G2S
715001929

OUTLANDER

FENDER FLARE

- Kit designed to deliver extra protection from dirt and debris, therefore a must if you enjoy riding in the mud.
- Made of injected plastic that hugs your vehicle fenders perfectly.
- Gives vehicle added flair for that rugged cool look.
- Includes front and rear extensions and all mounting hardware.

Fits: G2 (except X mr 850 & 1000R)
715001764

Fits: G2L
715001909

Fits: G2 (X mr models only)
715004250



NEW

FENDER FLARE EXTENSIONS

- Block terrain debris from kicking up onto you as you ride or damaging your vehicle thanks to these extra-large Fender Flare Extensions, which also include mud flaps for added protection from mud/snow, especially when riding with track kits.
- Made of High Molecular Weight Polyethylene (HMWPE) for advanced abrasion resistance.
- Include front and rear extensions.

Fits: G2
• Must be used with Fender Flare for G2 (715001764).
715003458

Fits: G2L
• Must be used with Fender Flare for G2L (715001909).
715003615



RENEGADE



FENDER FLARE

- Integrated extended Fender Flare for sporty look and full body protection from dirt and water.
- Includes front and rear extensions and all mounting hardware.

Fits: G2S (except X mr models)
715001681



OUTLANDER

OUTLANDER MAX PASSENGER SEAT KIT

• Perfect to replace used or damaged passenger seat.

Fits: G2 2015 & up, G2L
(MAX models only)

715002373

Fits: G2 2013-2014 (MAX models only
except with 400 engine)

715002032



OUTLANDER RENEGADE



FRONT SHOCK COVERS

- Feature ventilation holes.
- Offer added protection in rough terrain and weather conditions.
- Sold in pairs.

Fits: G2, G2L, G2S

71500301

HEAVY-DUTY SPRINGS

- Heavy-duty springs provide enhanced stiffness.
- Perfect for snow clearing and hauling heavy loads.
- Improves handling and helps prevent accidental overturns.
- Sold in pairs.
- Standard on Outlander Pro & Mossy Oak models

Fits: G2

Front

G2 (base model, DPS, XT, X mr with 650 engine only & Limited), G2S (base model with 500 & 570 engines only)

715003199

Rear

G2 (base model, DPS, XT & X mr with 650 engine only), G2S (base model with 500 & 570 engines only)

715003200



Front



Rear

FOX PERFORMANCE SHOCKS 1.5 PODIUM X RC2 HPG

- High-performance front and rear shocks.
- Allow handling to readily adapt to terrain and riding style.
- Easy-adjust dual-speed compression, rebound and preload settings.
- Standard on X xc.

Fits: G2 (except with 400 engine, X mr, Limited, & 6x6), G2 X mr 650 & G2S (base model & X mr 570 only)

715003201



OUTLANDER



YOSHIMURA SLIP-ON EXHAUST

- Made from 304-grade stainless steel.
- Better sounding, better looking and lighter than stock muffler.
- USDF/USDA approved spark arrester.
- NON EPA compliant (for racing application only).
- Not EC compliant.
- Fuel injection system tuning not required.

Fits: G2 (except 6x6 models)

715001738

RENEGADE



YOSHIMURA SLIP-ON EXHAUST

- Made from 304-grade stainless steel.
- Better sounding, better looking and lighter than stock muffler.
- USDF/USDA approved spark arrester.
- NON EPA compliant (for racing application only).
- Not EC compliant.
- Fuel injection system tuning not required.

Fits: G2S (except X mr models)

715001739

RADIATOR PROTECTOR

- Metal shield which mounts over radiator face, providing protection from stones and branches.

Fits: G2, G2S (except Renegade with 500 engine)

715001744

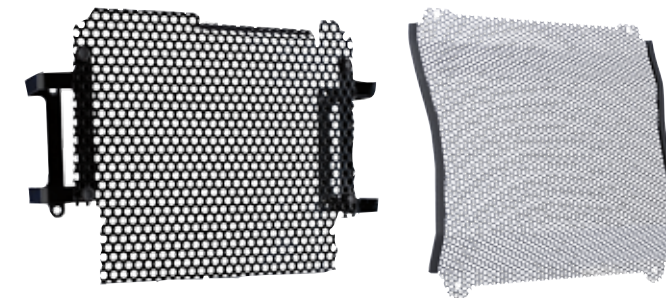

FOAM AIR FILTER BY TWINAIR†

- Maximizes performance by increasing air flow throughout RPM range.
- Maintenance-friendly, i.e. just wash, re-oil and re-use after riding in severely dusty/muddy environments.

Fits: G2, G2S

715001333



FOX SHOCKS

- Engineered for the more aggressive riders.
- Offers increased bump absorption and better roll control.
- Offers a slightly firmer ride than standard kits but remains very useable for all-around use.
- Kit includes 4 shocks and springs.
- Rebuildable.
- Threaded preload adjusters.

Fits: G2 (except with 400 engine, X mr, XT-P, Limited & 6x6), G2 X mr 650 & G2S (base model with 500 & 570 only)

715001471



CATCH THE VIDEO AT CAN-AMOFFROAD.COM

**BEST
TRACK
SYSTEM
OF ITS KIND.**



OUTLANDER RENEGADE

APACHE 360 TRACK SYSTEMS

- Highly engineered track system provides ultimate traction in snow and any other type of ground surface for your Can-Am vehicle.
- Front track design reduces vibration, eases turning and enhances performance in any hard packed conditions.
- The angled front lugs minimize resistance, and the way the lugs overlap over the wheels ensures smooth rolling.
- The rear track pattern and lug height are balanced for greater traction.
- Unique adjustable contact patch enables you to tackle the toughest conditions year round.
- This new system has two settings: the user can choose a better attack angle in rough terrain or greater flotation in deep snow.
- Thanks to the heightened rubber over molded heavy-duty double bearing wheels and offset wheel spacing, friction and vibration are reduced to a minimum while ensuring reliability.
- Easy installation and quick conversion from tires to tracks once the Apache 360 Mounting Kit is installed (sold separately).
- The DPS[®] module, included in the Apache 360 Mounting Kit, optimizes your Dynamic Power Steering (DPS) performance, maximizing steering agility at lower speeds while providing firmer steering at cruising speeds. It also provides a speed correction factor for the speedometer.
- EC compliant.

APACHE 360 TRACK SYSTEM

- Apache 360 Mounting Kit (715002388) is required (sold separately).

Fits: G2 (except 6x6 models), G2L, G2S
715001981

APACHE 360 LT TRACK SYSTEM

- The Apache 360 LT Track System offers the same features and technology as the Apache 360 Track System, plus some specific design elements.
- Heavy-duty components ensure reliability and the design offers excellent acceleration, turning, braking and side-hilling performance.
- Larger contact patch than the Apache 360 Track System by 15 in² (97 cm²) at front and 41 in² (265 cm²) at back.
- Higher ground clearance than the Apache 360 Track System by 3/4" front and 1.25" rear.
- Higher rear angle of attack.
- Apache 360 Mounting Kit (715002388) and Apache 360 LT ATV Adaptor (715003063) are required (sold separately).

Fits: G2 (except 6x6 models), G2S
715003064

APACHE 360 LT ATV ADAPTOR

- (Not illustrated)
- Required to install an Apache 360 LT Track System (715003064).
- Apache 360 Mounting Kit (715002388) also required.

Fits: G2 (except 6x6 models), G2L, G2S
715003063

APACHE 360 MOUNTING KIT

- (Not illustrated)
- Simple system that reduces installation time.
- Includes DPS Module.
- Requires Apache 360 LT ATV Adaptor (715003063) for installation of the Apache 360 LT Track System.

Fits: G2 (except 6x6 models), G2L, G2S
715002388

AIR INTAKE PRE-FILTER

- Adds extra protection for your engine in harsh riding conditions.
- Filter blocks particles larger than 0.005".
- A pre-filter is necessary to maintain the vehicle warranty when an Apache 360 Track System or an Apache 360 LT Track System is installed.

Fits: G2, G2L, G2S
715000291



**HIGHLY ENGINEERED TRACK
DESIGN PROVIDES ULTIMATE
TRACTION IN ANY TERRAIN AND
LOWEST STEERING EFFORT.**



**Unique adjustable contact patch system
to tackle the toughest year-round conditions.**



**Easy installation and quick conversion
from tires to tracks.**



**Rubber over molded heavy-duty double bearing
wheels and offset wheel spacing reduce
friction and vibration while ensuring reliability.**



PLOW KITS

OUTLANDER

60" (152 CM) ALPINE FLEX PLOW KIT

Fits: G2, G2L
715003149

THIS KIT INCLUDES

60" (152 cm) Alpine Flex Plow
715001181 - Black

Alpine Flex Push Frame
with Quick-Attach System
715001847

Plow Mounting Kit
715001411



60" (152 CM) ALPINE SUPER-DUTY STRAIGHT PLOW KIT

Fits: G2 (except 6x6 models), G2L
715003148

THIS KIT INCLUDES

60" (152 cm) Alpine Super-Duty
Straight Plow
715000648 - Yellow

Alpine Super-Duty Push Frame
with Quick-Attach System
715001182

Plow Mounting Kit
715001411



OUTLANDER RENEGADE

54" (137 CM) ALPINE SUPER-DUTY STRAIGHT PLOW KIT

Fits: G2 (except 6x6 models), G2L, G2S
715003147

THIS KIT INCLUDES

54" (137 cm) Alpine Super-Duty Straight
Plow
715000208 - Black

Alpine Super-Duty Push Frame
715001064

Plow Mounting Kit
715002858





OUTLANDER RENEGADE

PLOWS

ALPINE FLEX PLOW 54" (137 CM) & 60" (152 CM)

- Clears 50" (127 cm) or 54" (137 cm) when plow is angled.
- Ideal for clearing narrower areas, like sidewalks.
- Plow made of flexible UHMWPE, which delivers the highest impact strength of any thermoplastic presently made.
- Enormous flex action prevents damaging your plow when accidental impact happens.
- Impact absorption properties return plow to its original shape.
- Rearward release action practically eliminates jolts from being transferred to the driver or unit.
- Attaches and detaches effortlessly thanks to a fast and easy mounting system.
- Blade-turning mechanism mounted high to eliminate having to bend down to change or adjust blade's angle.
- High pivot point keeps plow on pavement.
- Compatible with all Alpine Flex Plow accessories to further enhance plow versatility.

Fits: G2, G2L, G2S

54" (137 cm)

715001677

60" (152 cm)

715001181



60" (152 cm)

BUILD YOUR CUSTOM ALPINE FLEX PLOW SYSTEM

01 FIND YOUR PLATFORM	02 MATCH THE PUSH FRAME	03 MATCH THE MOUNTING KIT	04 CHOOSE THE PLOW WIDTH	 <p>ADD ALPINE FLEX PUSH FRAME EXTENSION (715001389) IF USING ALPINE FLEX UHMW THERMOPLASTIC PLOW WITH APACHE 360 TRACK SYSTEM</p>
G2, G2L	715001847	715001411	60" (152 cm) Alpine Flex Plow 715001181 OR 54" (137 cm) Alpine Flex Plow 715001677	
G2S	715001848		Fits: Alpine Flex Push Frames (715001182, 715001474) and Alpine Flex Push Frames (715001847, 715001848).	

Some products shown may not be available or homologated in your country. Contact your BRP dealer for local details.

PUSH FRAME

ALPINE FLEX PUSH FRAME WITH QUICK ATTACH SYSTEM

- Refer to the chart on page 54 for the fitting.

715001848

715001847

- Includes cable saver limit switch and plow roller fairlead.



ALPINE FLEX PUSH FRAME EXTENSION

- Bolt-on push frame extension for use with Apache 360 Track System.
- Does not alter plow functionality.
- Fits Alpine Flex Push Frames (715001847 & 715001848).

Fits: Alpine Flex Plows

715001389



MOUNTING KIT

PLOW MOUNTING KIT

(Not illustrated)

- Required to install Alpine Super-Duty Push Frames with Quick Attach system (715001182, 715001474) and Alpine Flex Push Frames (715001847, 715001848).

715001411

- Mounting plate precision-designed to stay on year round without compromising ground clearance.
- Fits with or without Can-Am Skid Plates.

ALPINE FLEX PLOW ACCESSORIES

ALPINE FLEX PLOW EDGE MARKERS

- For a more accurate view of the width of your plow so you avoid damaging your curb, your car or your house.

Fits: Fit Alpine Flex Plows

715001388

ALPINE FLEX 8" (20 CM) PLOW EXTENSIONS

- These conveniently extend your Alpine Flex Plow.

Fits: Fit Alpine Flex Plows

715001385

ALPINE FLEX DRIFT CUTTER

- Keeps snow securely in the plow.
- Fits on either left or right side.
- Sold individually.
- Requires 8" (20 cm) Alpine Flex Extensions.

Fits: Alpine Flex Plows

715001386



ALPINE FLEX WEAR BLADE (STEEL)

- Long lasting wear blade that provides a sharper cut than the stock wear blade.
- Replaces stock wear blade.

Fits: Alpine Flex Plow

54" (137 cm)

715001704

Fits: Alpine Flex Plow

60" (152 cm)

715001476

- Stock replacement blade that is versatile for general plowing.

Fits: Alpine Flex Plow

54" (137 cm)

705203199

Fits: Alpine Flex Plow

60" (152 cm)

705202835

ALPINE FLEX WEAR BLADE (PLASTIC)

- Flexible UHMWPE plastic construction won't scratch your driveway.
- Replaces stock wear blade.

Fits: Alpine Flex Plow 54" (137 cm)

715001703

Fits Alpine Flex Plow 60" (152 cm)

715001475

ALPINE FLEX PLOW RUBBER FLAP

(Not illustrated)

- Keeps snow away from the driver.
- Minimizes snow flowing over plow.
- Increases snow rolling effect.

Fits: Alpine Flex Plow 60" (152 cm)

715001387

Fits: Alpine Flex Plow 54" (137 cm)

715001767



BUILD YOUR CUSTOM ALPINE SUPER-DUTY STEEL PLOW SYSTEM

01 FIND YOUR PLATFORM

02 CHOOSE YOUR TYPE OF PUSH FRAME

03 MATCH THE MOUNTING KIT

04 CHOOSE THE PLOW WIDTH



G2, G2L

715001064 + 715002858
OR
715001182 + 71500141166" (168 cm)
Alpine Super-Duty One Way State Plow
715000650 • Yellow
OR
60" (152 cm)
Alpine Super-Duty One Way State Plow715000649 • Yellow
715000207 • Black

OR

60" (152 cm)
Alpine Super-Duty Straight Plow
715000648 • Yellow
715000209 • Black

OR

54" (137 cm)
Alpine Super-Duty Straight Plow
715000647 • Yellow
715000208 • BlackADD ALPINE SUPER-DUTY
PUSH FRAME EXTENSION
(703500603) IF USING ALPINE
SUPER-DUTY STEEL PLOW
WITH APACHE 360
TRACK SYSTEM

G2S

715001064 + 715002858
OR
715001474 + 715001411

OUTLANDER RENEGADE

PLOWS

ALPINE SUPER-DUTY STRAIGHT PLOW

- Super-duty plow blades made from 12-gauge steel.
- Replaceable wear blades.
- Blades swivel left or right, 5 positions.
- Large pin designed for easy blade rotation to eliminate dirt and snow buildup at pivot point.
- Blade design provides best snow/dirt roll-off at any angle.
- Yellow-colored version Can-Am branded.

Fits: G2, G2L, G2S

60" (152 cm)

- When angled, clears 53½" (136 cm) path.

715000209 • Black
715000648 • Yellow

54" (137 cm)

- When angled, clears 48" (123 cm) path.

715000208 • Black
715000647 • Yellow

54" (137 cm)

ALPINE SUPER-DUTY ONE WAY STATE PLOW

- One-way "winged" state plow designed to throw snow higher.
- Wing end of plow measures 25" (63 cm) high and tapers down to 16" (41 cm).
- Rubber flap designed to keep snow away from driver.
- Yellow-colored version Can-Am branded.

Fits: G2, G2L, G2S

60" (152 cm)

715000649 • Yellow
715000207 • Black

66" (168 cm)

715000650 • Yellow



60" (152 cm)

PUSH FRAME

ALPINE SUPER-DUTY PUSH FRAME WITH QUICK ATTACH SYSTEM

- Tubes withstand roughest use.
- Mid-mount carriage provides up to 11½" (29 cm) lift.
- Fits all steel blade styles.
- Improved auto aligning quick-attach system, easy foot lever release pedal, cable saver limit switch preventing cable breakage by automatically stopping the winch.
- Fits on Plow Mounting Kit (715001411 & 715002858) depending on your vehicle platform.
- Refer to the chart above for the fitting.

715001182 • Includes plow roller fairlead
715001474

ALPINE SUPER-DUTY PUSH FRAME

- Super-duty push tubes withstand the roughest use.
- Mid-mount carriage provides up to 11½" (29 cm) of lift.
- Fits all steel blade styles.
- Quick-attach not included.
- Refer to the chart above for the fitting.

715001064



MOUNTING KIT

PLOW MOUNTING KIT

(Not illustrated)

- Required to install Alpine Super-Duty Push Frames with Quick Attach System (715001182, 715001474) and Alpine Flex Push Frames (715001847 & 715001848).
- Mounting plate precision-designed to stay on year round without compromising ground clearance.
- Fits with or without Can-Am Skid Plates.
- Refer to the chart above for the fitting.

715001411

PLOW MOUNTING KIT

(Not illustrated)

- Required to install Alpine Super-Duty Push Frame (715001064).
- Quick-release pins attach and detach plow blade and base assembly in minutes.
- Simplified installation.
- Can be used with or without Alpine Super-Duty Quick Attach System (715000731).
- No frame drilling required.
- Refer to the chart above for the fitting.

715002858

ALPINE SUPER-DUTY ACCESSORIES

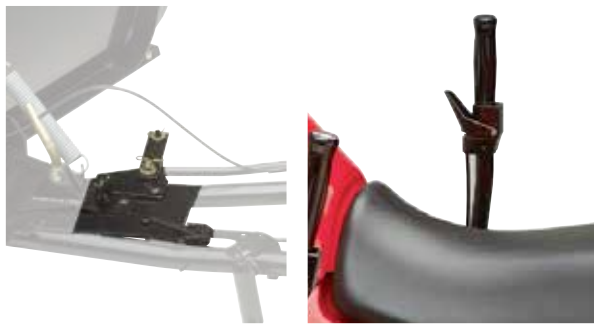

ALPINE SUPER-DUTY QUICK ATTACH SYSTEM

- Available as an option to upgrade Alpine Super-Duty Push Frame (715001064).
- The plow will be easy to install with this quick attach system.
- Durable with a powder-coated rust-resistant finish.

715000731



ALPINE SUPER-DUTY PUSH FRAME EXTENSION

- 12 1/4" (31 cm) chassis extension for use with Apache 360 Track System.
- Increases angle and enables extra blade rotation.
- Fits on Alpine Super-Duty Push Frame (715001063, 715001064, 715001182 & 715001474).

703500603

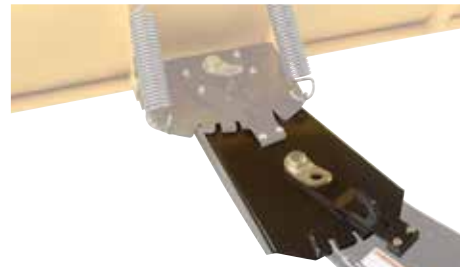

ALPINE SUPER-DUTY PULLEY KIT

- Pulley kit to be used in conjunction with the winch when using a snow plow.
- Recommended to increase winch efficiency.
- To be used with the XT Front Bumper.

Fits: Alpine Super-Duty Plow
715000279



ALPINE SUPER-DUTY DRIFT CUTTER

- Helps keep snow in the plow.
- Designed with a rear pivot point.
- Works with both Straight and One Way State Blades.

Fits: Alpine Super-Duty Plow

Left 715000217 **Right** 715000218



OTHER PLOW ACCESSORIES

ALPINE SYNTHETIC WINCH CABLE

- Specially designed for plowing applications.
- 8' (2.4 m) section of durable, extra-strong synthetic rope.
- Stands up to repeated, sharp angle pulls used to lift heavy plow blades.
- Temporarily replace your winch rope for plow season to save wear and tear on wire rope.

715000540



PLOW LIGHTS

- Featuring 35W H3 halogen bulbs and a lens design that achieves 110-degree beam spread to provide excellent lighting for plowing.

Fits: G2L
715000063



PLOW ROLLER FAIRLEAD

- Larger diameter lower roller reduces wear on wire rope for plow application.
- For use with Alpine Super-Duty Plow.

Fits: G2
705005715



REAR TIRE CHAINS

- Improve your traction in mud and snow.
- Sold in pairs.

26" x 10" x 12" 715500218 **25" x 10" x 12"** 715000225



TRAILERING COVERS

- X-attachment system.
- 300-denier solution-dyed, water-repellent 100% polyester construction.
- Fits with or without mirrors and windshield.
- Key areas are reinforced.
- Snug fitting and weather tough.

- Fits with or without trunk box and passenger seat.
- Has opening for access to the fuel tank.

Fits: G2 (except MAX models)
715001737

Fits: G2 (MAX models only)
715001736

- Fits with rack extensions.
- Has opening for access to the fuel tank.

Fits: G2L (except MAX models)
715002026

Fits: G2L (MAX models only)
715002025

- Fits with or without mirrors and windshield attachment brackets (windshield must be removed).

Fits: G2S (except X mr models)
715000683



LOCKABLE GAS TANK CAP

- Protects your fuel.
- Meets EPA requirements.

Fits: G2, G2L, G2S
860200387 • Black



CUP HOLDER

- Mounts easily to handlebars or racks.

715000121



LICENSE PLATE BRACKET

- Provides specific area to install license plate.
- Mounts to rear of vehicle.

Fits: G2L 715002498 **Fits: G2S** 715001401



FLAG

- Make sure everyone knows what you're riding.
- Perfect for the dunes and new riders.
- 8-foot (2.4 m) length.
- Includes flag mount (715000127).

715000277 • Yellow



DECAL

- Set of 2
- 2" x 6" (5 cm x 15 cm)

704901480



DECAL

- 9 per sheet
- 24" x 8" (60 cm x 20 cm)

704901481



DECAL

- 6" x 12 3/4" (15 cm x 32 cm)

704901483



DECAL

- 6" x 12 3/4" (15 cm x 32 cm)

704901484

FLAG MOUNT

715000127



OUTLANDER 6X6

APACHE 360 LT TRACK SYSTEM

- Exclusively for the Outlander 6x6.
- Cross obstacles up to 12" (30 cm).
- Enjoy superior acceleration, turning, braking, and side-hilling.
- Switch easily between enhanced attack angle or improved flotation.
- Reliable heavy-duty build.
- Can-Am designed technology.
- Delivers the highest ground clearance on the market.
- Mounting kit included.
- For winter use only.
- EC Compliant.

Fits: G2 (6x6 2016 and up models only)
715002386

Fits: G2 (6x6 2014-2015 models only)
619590299



Some products shown may not be available or homologated in your country. Contact your BRP dealer for local details.



OUTLANDER 6X6



HARD TOP

- The hard top provides a 116 Gal (440L) cargo box.
- Locking secures your belongings.
- The cover raises assisted by gas cylinders.

Fits: G2 (6x6 models only)
715002490 - Latin America / Asia Pacific
715002394 - Europe

SIDE WALLS AND TAIL GATE

- Allows for a quick and easy conversion of the cargo bed into a trunk with plenty of room.
- Rotationally molded walls provide extreme durability for hard work - in all conditions.

Fits: G2 (6x6 models only)
715002868 - Latin America / Asia Pacific
715001989 - Europe



LOG BARS

- Log bars allow you to convert the cargo bed into a perfect transport space for 4' (120 cm) timber.
- The driver's safety is guaranteed by the protective front screen.

Fits: G2 (6x6 models only)
715002486 - Latin America / Asia Pacific
715001987 - Europe



TAILGATE EXTENSION/DIVIDER

- The sturdy tailgate extension provides a 10" (25 cm) extension to the cargo space.
- Thanks to the longer cargo bed, even large loads pose no problem.
- With the help of LinQ quick locks, the extension also acts as a solid space divider for the cargo bed.

Fits: G2 (6x6 models only)
715002488 - Latin America / Asia Pacific
715002017 - Europe



TAILGATE LIMITER KIT

- 2 L-shape brackets that hold the tailgate open horizontally.
- Keeps tailgate flush with the rest of the flatbed for longer oversized cargo.

Fits: G2 (6x6 models only)
715002534 - Latin America / Asia Pacific
715002080 - Europe



OUTLANDER 6X6



18 GAL (70L) UTILITY BOX

- Wherever you go and whatever you do, this handy 18 Gal (70L) utility box is your mobile storage.
 - The lid keeps your equipment safe from the elements in all conditions.
 - Slides under the flatbed with handles for easy access.
- Fits: G2 (6x6 models only)**
715002487 - Latin America / Asia Pacific
715001999 - Europe



FLATBED PROTECTION TUBES

- Bolt-on bumpers for the sides of the 6x6 flatbed.
 - Protects the exterior plastic components of the flatbed from rocks, trees and other obstacles when traversing enclosed areas or loading cargo onto the bed.
- Fits: G2 (6x6 models only)**
715002489 - Latin America / Asia Pacific
715002030 - Europe



REAR WINCH KIT

- The remote-controlled rear winch is a godsend when you want to pull yourself out of a tough spot or move heavy loads.
 - Includes a fully-sealed Warn winch and all wiring and hardware needed for an easy and quick installation.
 - Pulling strength capability of 3,000 lb (1,361 kg).
 - 50 ft. of 3/16" (15.2 m of 4.8 mm) wire steel cable.
- Fits: G2 (6x6 models only)**
715002484 - Latin America / Asia Pacific
715002067 - Europe



OUTLANDER 6X6



TARPAULIN

- Fitted to cover all of the items in your cargo box thoroughly.
 - Prevents splash from entering cargo box.
 - Easily removable for quick access.
- Fits: G2 (6x6 models only)**
715002491 - Latin America / Asia Pacific
715002416 - Europe

STORAGE COVER

- (Not illustrated)
- For storage use only.
 - Heavy-duty elastic cord around bottom for secure fit.
 - 100-denier polyester construction.
 - Fits with or without windshield and mirrors.
- Fits: G2 (6x6 models only)**
715002492 - Latin America / Asia Pacific
715002415 - Europe



FULL BODY SKID PLATE

- A full body plastic skid plate (10 mm HDPE) designed to protect the frame and the engine case from rough terrain conditions.
 - The plastic allows your ATV to slide easily over stumps and logs.
- Fits: G2 (6x6 models only)**
715002485 - Latin America / Asia Pacific
860200896 - Europe

EXCLUSIVE WRAP KITS

SHOW OFF YOUR INDEPENDENCE WITH ANY OF THESE BOLD STATEMENTS FROM SCS.

The creative minds at SCS are constantly collaborating with BRP designers, coming up with innovative, perfectly-sized wrap designs that will complement your vehicle and refresh its look. You're unique. Your ride should be too.

MAVERICK X3



MAVERICK



Adding doors? We can add graphics that are a perfect match to any of our Maverick Wrap Kits!

DEFENDER



BRP BACKS THE BEST.¹ BRP LIMITED WARRANTY²

FOR NEW PARTS,
ACCESSORIES
AND RIDING GEAR.



GENUINE BRP PARTS AND ACCESSORIES
installed by you or your authorized BRP dealer

1 YEAR LIMITED WARRANTY**

AFTERMARKET PRODUCTS SOLD THROUGH BRP³

1 YEAR LIMITED WARRANTY**



RIDING GEAR

1 YEAR LIMITED WARRANTY**



HELMETS

4 YEARS LIMITED WARRANTY**

*PAC Warranty details may vary in your region. Contact your local dealer for regional details.

SCS wraps are of the highest quality, made with 0.004" engineering-grade vinyl overlaid with a 0.008" UV-protective laminate. That means vibrant colors, easy installation and a wrap that will hold up to the rigors of the off-road.
> SCS can even customize the color combinations; adding names, numbers and logos according to your exact specifications.
> Available for both 2-seat and 4-seat Maverick, Maverick X3 and Defender models.



Available at participating Can-Am dealers and scscanamgraphics.com

GET ALL THE DETAILS FROM YOUR CAN-AM OFF-ROAD DEALER

¹Use other than which the product is designed for will void the product lifetime warranty. ²Applies only to BRP-made products or aftermarket products made by accredited BRP partners. ³Purchased at an authorized BRP dealership / distributor or on a BRP-authorized online store. Other exclusions may apply, see complete limited warranty or contact your Can-Am off-road authorized dealer. ⁴Includes only BRP-approved aftermarket products and products made by currently accredited BRP partners. ⁵**Unless otherwise stipulated or required by law. This limited warranty does not apply to factory installed accessories. This limited warranty does not apply on Evinrude parts and accessories. This limited warranty is effective as of March 1st 2016.

CAN-AM SIDE-BY-SIDE VEHICLE ACCESSORIES



INTRODUCING NEW MAVERICK X3

70	COMPATIBILITY GUIDE
73	ROOFS
75	WINDSHIELDS & MIRRORS
77	DOORS & REAR WIND PROTECTION
78	SKID PLATES
79	BUMPERS & PROTECTION
84	SEATS
85	CARGO & RACKS
86	LIGHTING
89	ELECTRICAL
90	WINCHES & HITCHES
90	PERFORMANCE
91	COVERS



DEFENDER

70	COMPATIBILITY GUIDE
93	HARD CAB ENCLOSURES
95	SOFT CAB ENCLOSURES
98	ROOFS
103	WINDSHIELDS & MIRRORS
107	DOORS
110	REAR WIND PROTECTION
113	SKID PLATES
117	BUMPERS & PROTECTION
132	CARGO & RACKS
146	LIGHTING
152	ELECTRICAL
157	WINCHES & HITCHES
166	APACHE 360 LT TRACK SYSTEM
168	PLOWS
170	COVERS & ADD-ONS



MAVERICK

70	COMPATIBILITY GUIDE
96	SOFT CAB ENCLOSURES
100	ROOFS
105	WINDSHIELDS
106	MIRRORS
108	DOORS
112	REAR WIND PROTECTION
114	SKID PLATES
124	BUMPERS & PROTECTION
139	CARGO & RACKS
146	LIGHTING
153	ELECTRICAL
157	WINCHES & HITCHES
160	SEATS
161	PERFORMANCE
166	APACHE 360 LT TRACK SYSTEM
168	PLOWS
170	COVERS & ADD-ONS



COMMANDER

70	COMPATIBILITY GUIDE
94	HARD CAB ENCLOSURES
97	SOFT CAB ENCLOSURES
100	ROOFS
105	WINDSHIELDS
107	MIRRORS
108	DOORS
112	REAR WIND PROTECTION
116	SKID PLATES
127	BUMPERS & PROTECTION
139	CARGO & RACKS
146	LIGHTING
153	ELECTRICAL
157	WINCHES & HITCHES
160	SEATS
161	PERFORMANCE
167	APACHE 360 LT TRACK SYSTEM
168	PLOWS
170	COVERS & ADD-ONS

THE CHOICE IS YOURS.

ACCESSORIES FOR YOUR RIDE.

DUNE

MAKING IT THERE IS GREAT. MAKING IT THERE FIRST IS BETTER.



DUNE ACCESSORIES

- 1 Dune Front Bumper p. 83
- 2 Dune Rear Bumper p. 83
- 3 Front Intrusion Bar p. 81
- 4 Rear Cage Extension p. 82
- 5 Lower Door Panels p. 77
- 6 40" (102 cm) Baja Designs OnX6 Arc LED Light Bar p. 86
- 7 Light Support Bar p. 87
- 8 Lighted Whip Flag p. 89
- 9 Aluminum Roof p. 74
- 10 Complete MTX Audio System p. 89
- 11 Baja Designs Squadron Sport LED Light p. 87
- 12 Racing Side Mirrors p. 76
- 13 Electronic Device Holder p. 89



MAVERICK X3

UTILITY

GETTING IT DONE. IT'S IN YOUR BLOOD.



UTILITY ACCESSORIES

- 1 Bed Wall Extender p. 133
- 2 Headache Rack p. 132
- 3 Side Mirror p. 106
- 4 Xtreme Front Bumper Plates p. 119
- 5 Front Bumper p. 118
- 6 Front Corner Protectors p. 118
- 7 Half Windshield p. 104
- 8 Sport Roof p. 98
- 9 Light Rack p. 148
- 10 HID Lights by Hella p. 148
- 11 4" (10 cm) Round LED Lights (2 X 25 Watts) p. 149



DEFENDER

ADVENTURE

ALONE, IT'S A RIDE. WITH FAMILY, IT'S AN ADVENTURE.



ADVENTURE ACCESSORIES

- 1 Rear Wind Screen p. 112
- 2 Half Windshield p. 105
- 3 Sport Roof p. 101
- 4 XT Front Bumper p. 130



COMMANDER

THE CHOICE IS YOURS.

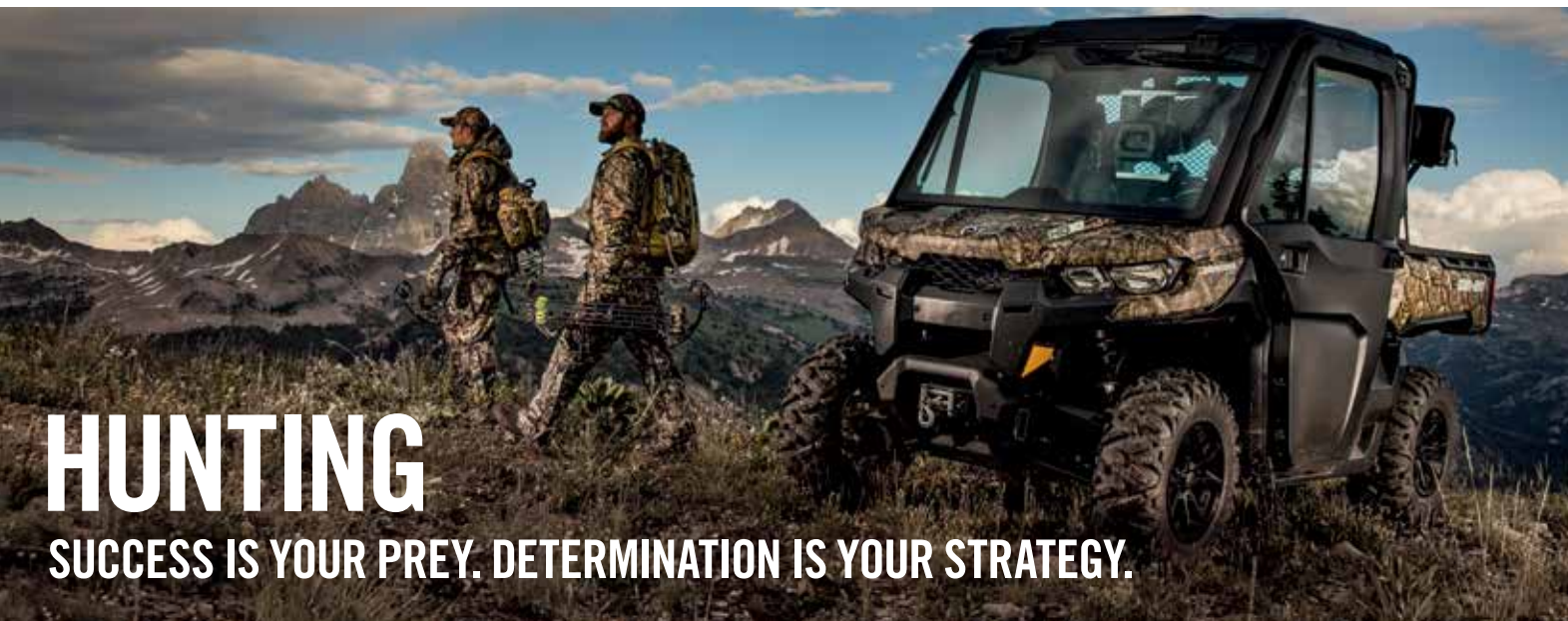

HUNTING

SUCCESS IS YOUR PREY. DETERMINATION IS YOUR STRATEGY.



MUD

MUD IS MEAN. YOU'RE MEANER.



WINTER

OTHERS HEAD SOUTH. YOU HEAD OUT.

ACCESSORIES FOR YOUR RIDE.

HUNTING ACCESSORIES

- 1 Sport Roof p. 98
- 2 Half Windshield p. 104
- 3 Headache Rack p. 132
- 4 Front Bumper p. 118
- 5 Gear Rail p. 140
- 6 Gun Boot 6.0 Impact by Kolpin p. 139
Gun Boot Mount by Kolpin p. 139



DEFENDER

MUD ACCESSORIES

- 1 Sport Aluminum Roof p. 101
- 2 Half Windshield p. 105
- 3 Front Pre-Runner Bumper p. 126
- 4 Rear Bumper p. 127
- 5 Rock Sliders p. 129
- 6 Radiator Protector p. 165
- 7 39" (99 cm) Double Stacked LED Light Bar (270 Watts) p. 146
- 8 Super Extended Fender Flare p. 162
- 9 Snorkel Kit p. 163



MAVERICK X xc

WINTER ACCESSORIES

- 1 Soft Cab Enclosure p. 95
- 2 Apache 360 LT Track System p. 166
- 3 Alpine Flex Plow Kit p. 168
- 4 Xtreme Front Bumper Plates p. 119
- 5 Front Bumper p. 118
- 6 Front Corner Protectors p. 118
- 7 Side Mirror p. 106
- 8 Can-Am Terra 45 by Superwinch p. 157
- 9 Light Rack p. 148
- 10 4" (10 cm) Round LED Lights (2 X 25 Watts) p. 149
- 11 15" (38 cm) Double Stacked LED Light Bar (90 Watts) p. 146



DEFENDER

SIDE-BY-SIDE VEHICLES ACCESSORY COMPATIBILITY GUIDE

WE'VE MADE THINGS SUPER SIMPLE.

Determine your model year, find your model and engine configuration, and that'll reveal your platform code. This code will let you know at a glance if the accessory is compatible with your vehicle.

RS = Maverick & Maverick MAX for all option packages (DPS, XC DPS, X xc, X mr, X ds & X rs)
 RU = Commander & Commander MAX for all option packages (DPS, X, XT, Mossy Oak Edition, XT-P & Limited)
 UR = Defender for all option packages (DPS, XT, XT CAB)
 SSP = Maverick X3 for all options packages (X ds, X rs)

	MODEL	ENGINE	PLATFORM
2011	Commander	800, 1000	RU
2012	Commander	800, 1000	RU
2013	Commander	800, 1000	RU
	Maverick	1000	RS
2014	Commander	800, 1000	RU
	Commander MAX	1000	RU
	Maverick	1000	RS
	Maverick MAX	1000	RS

EXAMPLE



AIR INTAKE PRE-FILTER

- Adds extra protection to your engine in harsh riding conditions.
- Filter blocks particles larger than 0.005" (0.1 mm).
- Necessary to maintain the vehicle warranty when tracks are installed.

Fits: RS (except X mr, X ds Turbo, Turbo, X rs Turbo 2016 & up models), RU 715000953



RU



RU

	MODEL	ENGINE	PLATFORM
2015	Commander	800, 1000	RU
	Commander MAX	1000	RU
	Maverick	1000	RS
	Maverick MAX	1000	RS



RS

	MODEL	ENGINE	PLATFORM
2016	Commander	800, 1000	RU
	Commander MAX	800, 1000	RU
	Maverick	1000	RS
	Maverick MAX	1000	RS
	Defender	HD8, HD10	UR



RS



UR

	MODEL	ENGINE	PLATFORM
2017	Commander	800, 1000	RU
	Commander MAX	800, 1000	RU
	Defender	HD8, HD10	UR
	Defender MAX	HD8, HD10	UR
	Maverick	1000	RS
	Maverick MAX	1000	RS
	Maverick X3	Turbo R	SSP



SSP

NEW MAVERICK X3 ACCESSORIES



THE ALL NEW
MAVERICK X3



MAVERICK X3



NEW

BIMINI ROOF WITH SUN VISOR

- Soft top with hard visor.
- UV-resistant, water-repellent 600-denier solution-dyed polyester with Can-Am branding.
- Allows user to stow the soft top on the hard visor.
- Easy, tool-less installation and removal with quick release 1/2 turn fasteners.

Fits: SSP
715002901



NEW

SPORT ROOF

- Impact-resistant injected polypropylene.
- Excellent protection from the elements.
- Provides excellent downhill visibility.
- Easy, tool-less installation.
- Standard on Maverick X3 X rs.
- Windshield compatible.

Fits: SSP
715002902



MAVERICK X3

NEW

ALUMINUM ROOF

- Formed aluminum roof 0.09" (2.3 mm) thick.
- Durable and lightweight.
- Sporty look.
- Windshield compatible.
- Easy and tool-less installation.

Fits: SSP

715002900



NEW

LONESTAR RACING ALUMINUM ROOF

- 0.083" (2.1 mm) thick aluminum roof.
- Durable and lightweight.
- Enhances the vehicle's racing appearance thanks to an authentic sporty look combined with unique graphics.
- Offers you protection from the elements with a personalized touch.
- Includes middle intrusion X bars for installation.
- Lower profile than other roofs.
- Compatible with Lonestar Racing Light Bar Racks.
- Not compatible with Light Support Bar and with Full Windshields.
- "Lonestar Racing for Can-Am" branded.

Fits: SSP

■ 715003923 - Black (with wrap kit)

■ 715004160 - Can-Am Red (with wrap kit)



Includes middle intrusion X bars for installation.

WINDSHIELDS & MIRRORS 75



MAVERICK X3

NEW

HALF WINDSHIELD

- High-impact-resistant durable polycarbonate half windshield.
- Formed polycarbonate construction for enhanced rigidity.
- Formulated to be non-yellowing, non-crazing, non-cracking with excellent UV resistance and optical clarity.
- Protects driver and passenger from the elements.
- Features reverse angle lip to deflect air flow.
- Quick and easy tool-less installation or removal.

Fits: SSP

715002909





MAVERICK X3



NEW

FULL WINDSHIELD

- High-impact-resistant durable polycarbonate full windshield.
- Formed polycarbonate construction for enhanced rigidity.
- Formulated to be non-yellowing, non-crazing, non-cracking with excellent UV resistance and optical clarity.
- Protects driver and passenger from the elements.
- Quick and easy tool-less installation or removal.

Fits: SSP

715002907



NEW

FULL WINDSHIELD - HARDCOATED

- High-impact-resistant Quantum¹ hardcoated polycarbonate full windshield.
- Formed polycarbonate construction for enhanced rigidity.
- Provides excellent optical clarity and better abrasion resistance.
- Protects driver and passenger from the elements.
- Quick-attach brackets procure fast, easy and tool-less installation and removal.

Fits: SSP

715002908

NEW

RACING SIDE MIRRORS

- Race-inspired design features rugged black nylon 6/6 construction with coated cast-aluminum mount.
- Dual-adjustment provides optimal field of view (FOV).
- Multi-position adjustable ball-joint mounted mirrors.
- Flat optics deliver improved distance perception.
- Spring-loaded pivots let mirrors fold back completely.
- Not compatible with Lonestar Racing Light Racks.
- Sold in pairs.

Fits: SSP

715002898



DOORS & REAR WIND PROTECTION 77



MAVERICK X3



NEW

LOWER DOOR PANELS

- Robust injection-molded polypropylene construction designed to match vehicle.
- Extends stock doors at bottom to protect cab area.
- A great-looking add-on.
- Easy and quick installation.
- Sold in pairs.

Fits: SSP

715002903



NEW

REAR WIND SCREEN

- Full rear mesh coverage reduces windshield backdraft.
- Roll-bar mounted.
- Can-Am logo on black mesh.

Fits: SSP

715002897

HMWPE SKID PLATES

Our Plastic Plates glide smoothly and silently over obstacles, offering great protection in rough terrain. Made of abrasion-resistant thermoformed High Molecular Weight Polyethylene (HMWPE). Lighter than aluminum. Cold cracking resistant. High impact energy absorption.

MAVERICK X3

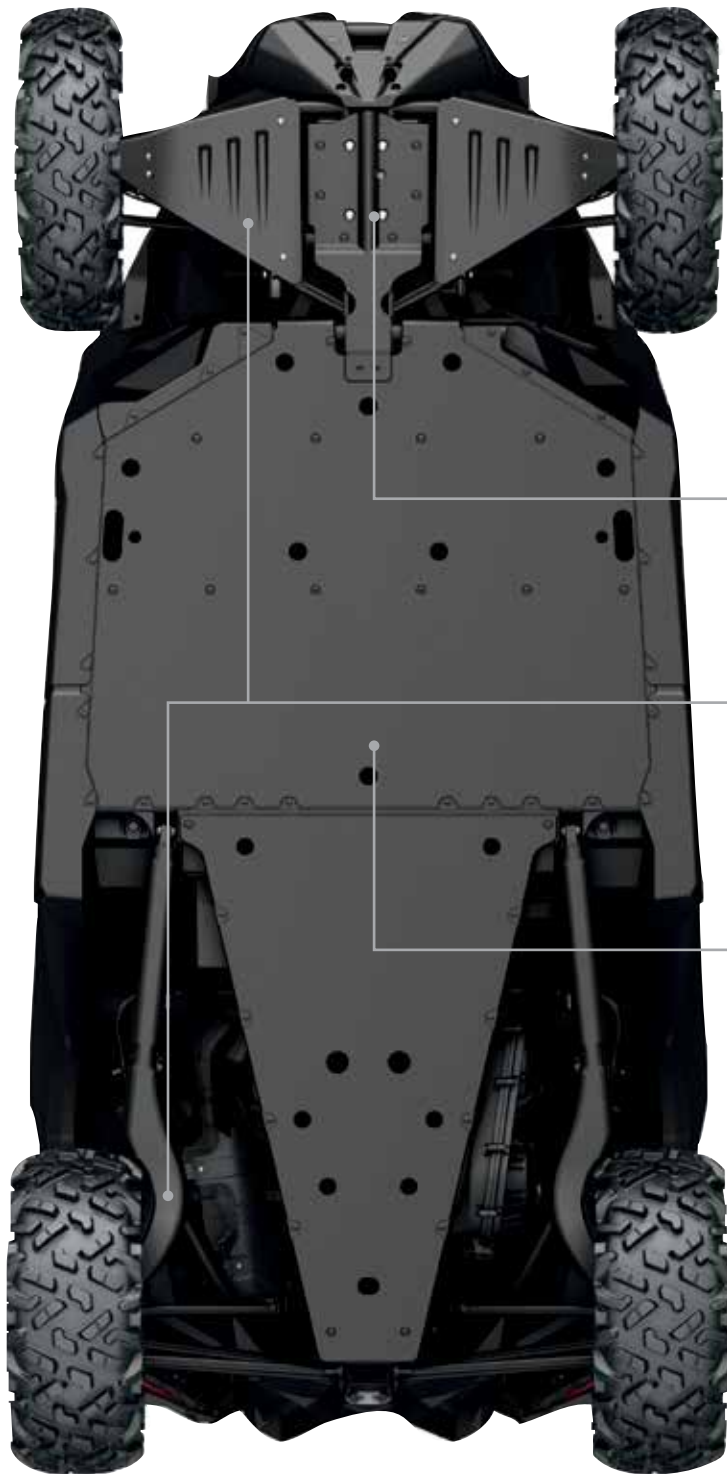

SSP (except X rs models)	SSP
HMWPE SKID PLATE PROTECTION KIT	
INCLUDES: · HMWPE Front A-Arm and Trailing Arm Protectors · HMWPE Underbelly Plates · HMWPE Front Skid Plates	
NEW 715003713	
INDIVIDUAL HMWPE SKID PLATES	
HMWPE FRONT SKID PLATE	
· Thermoformed HMWPE construction.	
NEW 715003933	
HMWPE FRONT A-ARM AND TRAILING ARM PROTECTORS	
· Thermoformed HMWPE construction. · Includes Front A-Arm and Trailing Arm protectors. · Can-Am branded.	
NEW 715002905	
HMWPE UNDERBELLY PLATE	
· Ultra-sturdy 3/8" (9.5 mm) thickness. · Provides mid and rear protection. · Standard on Maverick X3 X rs.	
NEW 715002904	

MAVERICK X3



NEW

LONESTAR RACING FRONT BUMPER

- Made of 1.5" (3.8 cm) diameter steel tubing with durable powder coat finish with a 1/8" (3 mm) thick aluminum plate for added vehicle-front protection in extreme driving conditions.
- Sleek styling enhances the vehicle's race-inspired look.
- Not winch compatible.
- "Lonestar Racing for Can-Am" branded.

Fits: SSP

- 715003914 - Black
- 715004161 - Can-Am Red



NEW

LONESTAR RACING REAR BUMPER

- Made of 1.5" (3.8 cm) diameter steel tubing with durable powder coat finish.
- Provides additional vehicle-rear bodywork and exhaust system protection in extreme driving conditions.
- Sleek styling enhances the vehicle's race-inspired look.
- Compatible with Lonestar Spare Tire Holder and Lonestar Racing Rear Intrusion Bar.
- Not hitch compatible.
- "Lonestar Racing for Can-Am" branded.

Fits: SSP

- 715003915 - Black
- 715004162 - Can-Am Red

MAVERICK X3



NEW

LONESTAR RACING FRONT INTRUSION BAR

- Made of 1.5" (3.8 cm) diameter steel tubing with durable powder coat finish.
- Enhances the racing look of the vehicle.
- Compatible with Lonestar Racing Aluminum Roof.
- Not compatible with windshields, bimini roof and sport roof.
- "Lonestar Racing for Can-Am" branded.

Fits: SSP

- 715003916 - Black
- 715004163 - Can-Am Red



NEW

LONESTAR RACING REAR INTRUSION BAR

- Made of 1.5" (3.8 cm) diameter steel tubing with durable powder coat finish.
- Sleek styling enhances the vehicle's race-inspired look.
- Required for the installation of the Lonestar Racing Spare Tire Holder.
- "Lonestar Racing for Can-Am" branded.

Fits: SSP

- 715003918 - Black
- 715004164 - Can-Am Red



NEW

LONESTAR RACING SPARE TIRE HOLDER

- Made of 1.5" (3.8 cm) diameter steel tubing with durable powder coat finish.
- Adjustable height for different tire width and sizes.
- Requires Lonestar Racing Rear Bumper and Lonestar Racing Rear Intrusion Bar for installation.
- Not compatible with the Wheel Jack.
- Spare tire not included.
- "Lonestar Racing for Can-Am" branded.

Fits: SSP

- 715003922 - Black
- 715004166 - Can-Am Red



NEW

LONESTAR RACING ROCK SLIDERS

- Made of 1.5" (3.8 cm) diameter steel tubing with durable powder coat finish filled with 1/8" (3 mm) aluminum plate.
- Protects vehicle sides from large obstacles.
- Sleek styling enhances the vehicle's race-inspired look.
- "Lonestar Racing for Can-Am" branded.
- Sold in pairs.

Fits: SSP

- 715003921 - Black
- 715004165 - Can-Am Red



MAVERICK X3



NEW

FRONT INTRUSION BAR

- Matches vehicle styling.
- Inside and outside anti-corrosion coating with durable powder coat finish steel intrusion bar.
- Tube design reduces obstructed lines of sight and blind spots for better visibility.
- Not compatible with windshields and Lonestar Racing Aluminum Roof.

Fits: SSP

- 715002889 - Black
- 715003435 - Can-Am Red





MAVERICK X3

NEW

FRONT PRE-RUNNER BUMPER

- Made of 1.5" (3.8 cm) diameter steel tubing with a 1/8" (3 mm) aluminum plate for extra durability.
- Inside and outside anti-corrosion coating with durable powder coat finish.
- Added heavy-duty protection in extreme driving conditions.
- Includes integrated winch mounting plate and mount points for lights.

Fits: SSP

- 715002878 - Black
- 715003433 - Can-Am Red



NEW

REAR PRE-RUNNER BUMPER

- Extra-durable 1.5" (3.8 cm) diameter steel tubing with a 1/8" (3 mm) aluminum plate.
- Inside and outside anti-corrosion coating with durable powder coat finish.
- Protects vehicle bodywork and exhaust system.
- Rear receiver hitch compatible.
- Required for installation of the Rear Cage Extension.

Fits: SSP

- 715002880 - Black
- 715003436 - Can-Am Red



NEW

REAR CAGE EXTENSION

- Durable 1.5" (3.8 cm) diameter steel tubing.
- Inside and outside anti-corrosion coating with durable powder coat finish.
- Allows holding a spare tire in place (tire not included).
- Custom tie-down strap for fast tire installation or removal.
- Rear Pre-Runner Bumper required for installation.
- Not compatible with LinQ Pivoting Rack and cargo boxes (except LinQ 20 Gal (73L) Deluxe Modular Bag).

Fits: SSP

- 715002890 - Black
- 715003434 - Can-Am Red



MAVERICK X3



NEW

DUNE FRONT BUMPER

- Made of 1.5" (3.8 cm) diameter aluminum tubing with a 1/8" (3 mm) aluminum plate.
- Inside and outside anti-corrosion coating with durable powder coat finish.
- Provides added protection without sacrificing the agility and performance advantages of a lighter weight design.
- Features a more pronounced attack angle and integrated mounting points for lights.
- Not winch compatible.

Fits: SSP

- 715002961 - Black
- 715003432 - Can-Am Red



NEW

DUNE REAR BUMPER

- Made of 1.5" (3.8 cm) diameter aluminum tubing with a 1/8" (3 mm) aluminum plate.
- Inside and outside anti-corrosion coating with durable powder coat finish.
- Provides added protection without sacrificing the agility and performance advantages of a lighter weight design.
- Protects vehicle bodywork and exhaust system.
- Rear receiver hitch compatible.
- Not compatible with Rear Cage Extension.

Fits: SSP

- 715002962 - Black
- 715003437 - Can-Am Red



NEW

ROCK SLIDERS

- Made of heavy-duty 1.5" (3.8 cm) diameter steel tubing.
- Inside and outside anti-corrosion coating with durable powder coat finish.
- Protect vehicle's sides and undercarriage against large obstacles.
- Support plate adds rigidity and style.
- Sold in pairs.

Fits: SSP

- 715002963 - Black
- 715003438 - Can-Am Red



NEW

SUPER EXTENDED FENDER FLARES

- Extended fender flares made from injection-molded polypropylene.
- Keep mud and debris out of vehicle.
- Designed for quick and easy installation.
- Include front and rear extensions and mounting hardware.

Fits: SSP

715002973



MAVERICK X3



NEW

BEARD SEATS

- True performance seating for driver and passenger.
- Designed specifically for side-by-side vehicle applications.
- Offer great posture for both driver and passenger during intense riding conditions, thanks to the ideal seat angle and wide pitch range.
- Feature a high level of containment support, which gives superior comfort and stability.
- Hard fiberglass shell covered with sculpted foam and wrapped with a custom cover of premium marine-grade vinyl, which is durable in all driving conditions and resistant to mildew and fading.
- Enhance the racing look of the vehicle.
- No additional seat mounts required.
- Requires 4-point harness (715003767, 715003766).
- Sold in pairs.

Fits: SSP

- 715004194 - Circuit Yellow
- 715004195 - Can-Am Red
- 715004196 - Steel Grey



NEW COMING SOON

4-POINT HARNESS

- Reduce submarining.
- Exclusive controlled decelerator absorbs energy in case of an accident.
- No uncomfortable crotch strap.
- Easy one-click latch and release.
- Drivers harness includes safety buckle switch.
- Patent pending.

715003767 - Passenger
715003766 - Driver



Some products shown may not be available or homologated in your country. Contact your BRP dealer for local details.

MAVERICK X3



NEW

LinQ 8 GAL (30L) COOLER BOX

- Rotomolded construction provides exceptional rigidity and durability along with optimal ice retention.
- Premium-quality foam insulation.
- Integrated, fully-removable compartment protects food.
- Weather-resistant, lockable.
- Convenient drain plug.
- Fits on all vehicles using a LinQ rack.

Fits: RS, SSP
715002892



NEW

LinQ PIVOTING RACK

- LinQ latched rack allows for extra LinQ mounted accessories or for carrying a spare tire.
- Includes custom tie-down strap for fast spare tire installation or removal.
- Gas-cylinder pivot action, locks in the raised position.
- Trunk Boxes over 20 Gal (74L) do not fit on the vehicle when the rack is installed.
- Not compatible with Rear Intrusion Bars and Rear Cage Extension.

Fits: SSP

- 715002881 - Black
- 715003439 - Can-Am Red

FOR OTHER CARGO AND RACK ACCESSORIES THAT FIT YOUR MAVERICK X3 CONSULT P.143-145



MAVERICK X3



NEW

40" (102 CM) BAJA DESIGNS ONX6 ARC LED LIGHT BAR

- Made by Baja Designs.
- 25,800 lumens utilizing 24 Cree XM-L2 LEDs.
- Driving/Combo light pattern for smooth blend of light for both near field applications and distance.
- Dual intensity (high/low) settings + strobe mode.
- Designed for installation onto Light Support Bar equipped roofs.
- Requires Light Power Cable and Light Support Bar.

Fits: SSP
710004630



NEW

10" (25 CM) BAJA DESIGNS ONX6 LED LIGHT BAR

- Made by Baja Designs.
- 6,450 lumens utilizing 6 Cree XM-L2 LEDs.
- Driving/Combo light pattern for smooth blend of light for both near field applications and distance.
- Dual intensity (high/low) settings + strobe mode.
- Designed for installation onto Pre-Runner and Dune bumpers and/or Light Support Bar equipped roofs.
- Requires Light Power Cable.

Fits: SSP
710004881

FOR OTHER LIGHTING ACCESORIES THAT FIT YOUR MAVERICK X3 CONSULT P.146-149

Some products shown may not be available or homologated in your country. Contact your BRP dealer for local details.

MAVERICK X3



NEW

BAJA DESIGNS XL SPORT LED LIGHTS

- Made by Baja Designs.
- 1,800 lumens utilizing 4 Cree XP-G2 LEDs.
- Spotlight pattern for long range lighting.
- High Speed Spot features a longer and narrower beam focus for illumination farther down.
- Designed for installation onto Pre-Runner and Dune bumpers and/or Light Support Bar equipped roofs.
- Require Light Power Cable.
- Sold in pairs.

Fits: SSP
710005287



NEW

BAJA DESIGNS SQUADRON SPORT LED LIGHTS

- Made by Baja Designs.
- 1,800 lumens utilizing 4 Cree XP-G2 LEDs.
- Designed for installation onto Pre-Runner bumpers and/or Light Support Bar equipped roofs.
- Wide cornering light pattern designed specifically for cornering, dust and/or fog conditions.
- Require Light Power Cable.
- Sold in pairs.

Fits: SSP
710004648



NEW

BAJA DESIGNS XL80 LED LIGHTS

- Made by Baja Designs.
- 9,500 lumens utilizing 4 Cree XHP50 LEDs.
- Dual intensity (high/low) settings.
- Driving/Combo light pattern for smooth blend of light for both near field applications and distance.
- Designed for installation onto Pre-Runner and Dune bumpers and/or Light Support Bar equipped roofs.
- Require Light Power Cable.
- Sold in pairs.

Fits: SSP
710005041

01 CHOOSE YOUR MOUNT POINT	02 CHOOSE YOUR LIGHTS								
	BAJA DESIGNS					CAN-AM			
	10" (25 CM) ONX6 LED LIGHT BAR	40" (102 CM) ONX6 ARC LED LIGHT BAR	XL SPORT LED LIGHTS (SOLD IN PAIRS)	SQUADRON SPORT LED LIGHTS (SOLD IN PAIRS)	XL80 LED LIGHTS (SOLD IN PAIRS)	10" (25 CM) DOUBLE STACKED LED BAR	15" (38 CM) DOUBLE STACKED LED BAR	39" (99 CM) DOUBLE STACKED LED BAR	4" (10 CM) ROUND LED (SOLD IN PAIRS)
	Consult p.144 for more information on these lights								
FRONT PRE-RUNNER OR DUNE BUMPERS	710004881 PLUS 715002885 (Power Cable)	NA	710005287 PLUS 715002884 (Power Cable)	710004648 PLUS 715002884 (Power Cable)	710005041 PLUS 715003729 (Power Cable)	715002933 PLUS 715003417 (Power Cable)	715002934 PLUS 715003417 (Power Cable)	NA	715002935 PLUS 715003417 (Power Cable)
LONESTAR RACING FRONT BUMPER	NA	NA	NA	NA	NA	NA	NA	NA	NA
LIGHT SUPPORT BAR	710004881 PLUS 715002885 (Power Cable)	710004630 PLUS 715002885 (Power Cable)	710005287 PLUS 715002884 (Power Cable)	710004648 PLUS 715002884 (Power Cable)	710005041 PLUS 715003729 (Power Cable)	715002933 PLUS 715003417 (Power Cable)	715002934 PLUS 715003417 (Power Cable)	715002932 PLUS 715003141 (Light Mounting Kit)	715002935 PLUS 715003417 (Power Cable)
LONESTAR RACING 40" (102 CM) LED LIGHT BAR RACK	NA	710004630 PLUS 715002885 (Power Cable)	NA	NA	NA	NA	NA	NA	NA
LONESTAR RACING LIGHT RACK	NA	NA	710005287 PLUS 715002884 (Power Cable)	NA	710005041 PLUS 715003729 (Power Cable)	NA	NA	NA	NA

03 ORDER

ORDER ALL PART NUMBERS IN INTERSECTING BOX

*NOTE: For each Light Kit bought, one Light Power Cable or Mounting Kit is required. When installing more than one lights kits, additional Light Power Cable or Mounting Kit is required.

*All lights are intended for Off-Road use only.

MAVERICK X3



NEW

LIGHT SUPPORT BAR

- Sleekly-styled rugged aluminum construction.
- Accommodates light bars and spotlights with or without any roof and windshield combination.
- Full vehicle width to allow the installation of any large LED light bar.
- Required for light installation on vehicle's roof.
- Lights sold separately.

Fits: SSP
715003529

NEW

LIGHT POWER CABLE

- (Not illustrated)
- Required for installation of Baja Designs LED lights onto roof or bumper.

Fits: SSP

715002885 - 10" (25 cm) & 40" (102 cm) Baja Designs OnX6 LED Light Bars
715002884 - Baja Designs XL Sport LED Light & Baja Designs Squadron Sport LED Light
715003729 - Baja Designs XL80 LED Light

NEW

LIGHT MOUNTING KIT FOR LED LIGHT BAR

- (Not illustrated)
- Required for installation of the 39" (99 cm) single and double LED Light Bars.
- Light Support Bar required for installation.

Fits: SSP
715003141

NEW

LIGHT POWER CABLE

- (Not illustrated)
- Required for installation of 10" (25 cm), 15" (38 cm) and 17" (43 cm) single and double LED Light Bars and 4" (10 cm) Round LED Lights.
- For bumper and roof mounting locations.

Fits: SSP
715003417



NEW

LONESTAR RACING 40" (102 CM) LED LIGHT BAR RACK

- Designed for use with 40" (102 cm) Baja Designs OnX6 Arc LED Light Bar.
- Enhances the vehicle's race-inspired look.
- Compatible with Aluminum Roof, Lonestar Racing Aluminum Roof and Sport Roof.
- Not compatible with Racing Side Mirrors.
- Lights sold separately.

Fits: SSP
715003920



NEW

LONESTAR RACING LIGHT RACK

- Designed for use with Baja Designs XL80 LED Light and Baja Designs XL Sport LED Light.
- Accommodates up to two pairs of XL Lights.
- Compatible with Lonestar Racing Aluminum Roof, Aluminum Roof and Sport Roof.
- Not compatible with Racing Side Mirrors.
- Lights sold separately.

Fits: SSP
715003948



MAVERICK X3

NEW COMING SOON

COMPLETE MTX AUDIO SYSTEM

- Bluetooth 5™ equipped 400(RMS)/800W Audio System by MTX.
- Designed to be Can-Am-tough in the most demanding riding conditions.
- Includes front-dashboard and rear-roll-cage mounted stereo speakers and head unit with an integrated 6.5" (16.5 cm) subwoofer.
- Add the Electronic Device Holder to securely hold your Bluetooth device ready to play your favorite tunes.

715002873



MAVERICK X3



NEW

LIGHTED WHIP FLAG

- A must for riding the dunes.
- 5W Cree LED.
- 5 colored lenses to allow personalization.
- Glow-through whip, quickly-removable and replaceable pole.
- Increases vehicle's visibility.
- Meets most dune-area requirements.
- Die cast aluminum base, acetal hand nut.
- Includes mounting brackets and wiring.
- 4' (1.2 m) flag mounts on top of the roll cage.
- Can be installed on both sides of a vehicle.

Fits: SSP
715002886



NEW

ELECTRONIC DEVICE HOLDER

- A great in-ride entertainment system platform.
- Robust injected-polypropylene construction allows for right fit and easy installation.
- Adjustable unit safely holds most tablets and smartphones between dimensions of 5.1" (13 cm) and 10" (25.4 cm) (with protective case).
- Combines seamlessly with Complete MTX Audio System.
- Allows the installation of Garmin Montana 680T GPS.
- Integrated storage (1 Gal (3.8L) capacity) with access to the dash 12V outlet for device charging.

Fits: SSP
715002874



FOR OTHER ELECTRONIC ACCESSORIES THAT FIT YOUR MAVERICK X3 CONSULT P.153-156

WINCHES & HITCHES

MAVERICK X3

NEW

REAR RECEIVER HITCH

- E-coated finish.
- Fixed mounting point for trailer ball to provide vehicle with towing capabilities.
- This hitch offers 1,300 lb (590 kg) of towing capacity.
- Rugged lightweight steel construction.

Fits: SSP
715002883 - Black
715003938 - Can-Am Red



NEW

WINCH ELECTRICAL HARNESS

- (Not illustrated)
- Required for winch installation.

Fits: SSP
715003585

FOR OTHER ACCESSORIES, CONSULT THE WINCHES & HITCHES SECTION FOR DEFENDER / MAVERICK / COMMANDER P.157-159

Some products shown may not be available or homologated in your country. Contact your BRP dealer for local details.

MAVERICK X3



NEW

LONESTAR RACING FIRE EXTINGUISHER SUPPORT

- Quick release support that allows you to slide the fire extinguisher out in a matter of seconds in an emergency situation.
- Made of billet anodized black aluminum.
- Fits 1.85" (4.7 cm) tubing.
- Can be fixed everywhere on the cage.
- Provides you with the safety and security of having dependable emergency equipment on board.
- Comes with both billet mounts, quick-pull pin, mounting plate and 2 clamps.
- Fire extinguisher sold separately.
- "Lonestar Racing for Can-Am" branded.

Fits: SSP
715003734



NEW

LONESTAR RACING NUMBER PLATE HOLDER

- Includes a pair of sturdy aluminum number plates that mount on either side of the vehicle rear.
- Styling enhances the vehicle's race-inspired look while adding a personal touch.
- Black background.
- Not compatible with LinQ Pivoting Rack.
- Numbered decals are available through SCS Unlimited.
- "Lonestar Racing for Can-Am" branded.

Fits: SSP
715003943



NEW

PERFORMANCE TWIN AIR FILTER

- The best choice for the harshest conditions.
- Multiple staged oiled filtering foam for superior dust retaining capacity with high airflow.
- Washable and reusable.

Fits: SSP
715002895



NEW

FOAM REPLACEMENT

- (Not illustrated)
- Replacement foam for Twin Air Filter.

Fits: SSP
707800713



COVER

MAVERICK X3

NEW

TRAILERING COVER

- Can-Am branded 300-denier solution-dyed, water-repellent polyester construction.
- Allows access to fuel and passenger compartments.
- Heavy-duty strap around bottom for secure fit.
- Lined with soft fabric in the windshield area to prevent scratching.
- Fits with or without accessories.
- Airflow design reduces aerodynamic drag and improves fuel economy.

Fits: SSP
715002877





DEFENDER MAVERICK COMMANDER ACCESSORIES



HARD CAB ENCLOSURES 93

ADD FLEXIBILITY AND PRACTICALITY TO YOUR VEHICLE WITH OUR READY-TO-GO HARD CAB ENCLOSURES.

We've got an option that lets you enjoy your Can-Am in perfect comfort, in any season. It's totally up to you... make things really easy and choose one of our ready-to-go, ready-for-anything cab enclosures or create your own from an extensive range of components and accessories. Mix and match to suit your exact needs by taking advantage of our innovative modular approach to cabs. There's an endless number of possible combinations, so let your imagination run wild.

DEFENDER



NEW

DELUXE XT RIGID CAB ENCLOSURE

- Rigid cab enclosure ideal for Defender XT vehicles that come stock with a roof, but also fits on Base and DPS models with the addition of a roof.
- Offers good driver and passenger protection from the elements.

Included:

- Flip Glass Windshield (715002942)
- Rear Polycarbonate Window (715002922)
- Full Doors with Power Windows (715001968)
- Wiper and Power Windows Cable (710004462)
- Roof Power Cable (715003094)
- Sport Roof Seal Kit (715003126)

Fits: UR (except MAX models)

715003482 - Black

NEW

PREMIUM RIGID CAB ENCLOSURE

(Not illustrated)

- Provides driver and passenger with the best protection from the elements and the cold, and features the most complete top-of-the-line accessories our product line-up has to offer.

Included:

- Sport Roof with Liner (715002511)
- Flip Glass Windshield with Wiper and Washer Kit (715002441)
- Full Doors with Power Windows (715001968)
- Rear Glass Window with Sliding Panel (715002440)
- Wiper and Powered Windows Cable (710004462)
- Roof Power Cable (715003094)

Fits: UR (except MAX models)

715001966

NEW

SPORT ROOF SEAL KIT

(Not illustrated)

Fits: UR (except MAX models)

- Necessary when installing individual cab components with Sport Roof (715002430) or when installing the front and rear roof liners (715003098, 715003099).

715003126

100% MODULAR. IT'S YOUR CAB, YOUR WAY.

Can-Am's got a wide selection of components, so if you feel like designing your own cab, your own way, our modular system can make it happen. This is flexibility and versatility at work for you. Simply pick the windshield (p.104), doors (p.107), rear window (p.110) and roof (p.98) of your choice, and you're off. Whatever you choose to build your cab with we guarantee the components will work together, because they were designed to work together.

COMMANDER



RIGID CAB ENCLOSURE

- Encloses cab of vehicle to protect rider and passenger from the elements and cold.
- Compatible with gear rail bar with an adaptor.
- Cannot be used with Snorkel Kit (715001978).

- Included:**
- Sport Roof (715001679)
 - Glass Windshield with wiper package (715001678)
 - Rear Window (715001300)
 - Full Doors (715001301)

Fits: RU 2014 & up (except MAX models)
715001299

 CATCH THE VIDEO AT CAN-AMOFFROAD.COM

100% MODULAR. IT'S YOUR CAB, YOUR WAY.

Can-Am's got a wide selection of components, so if you feel like designing your own cab, your own way, our modular system can make it happen. This is flexibility and versatility at work for you. Simply pick the windshield (p.105), doors (p.109), rear window (p.112) and roof (p.100) of your choice, and you're off. Whatever you choose to build your cab with we guarantee the components will work together, because they were designed to work together.

Some products shown may not be available or homologated in your country. Contact your BRP dealer for local details.

GET MORE OUT OF YOUR CAN-AM WITH OUR SOFT CAB ENCLOSURES OR CREATE ONE OF YOUR OWN.

Looking for a complete soft cab enclosure? Or do you already have the roof and windshield and are looking to add more cab components? Either way we've got everything you need to begin getting more out of your Can-Am today.

Check out our off-the-shelf soft cabs or choose from a wide selection of soft cab components and you'll see at once that our commitment to complete modularity means everything just works. We love making your life easier.

DEFENDER



SOFT CAB ENCLOSURE

- Protection for rider and passenger from the elements.

- Included:**
- Bimini Roof with Sun Visor (715002918 (not sold separately)/715003030)
 - Full Windshield - Hardcoated (715002432)
 - Soft Doors (715002919/715003033)
 - Soft Rear Panel (715002920)

Fits: UR (except MAX models)
715002917 - Black

Fits: UR (MAX models only)
NEW 715003032 - Black

- Included:**
- Bimini Roof with Sun Visor (715002849/715003469)
 - Full Windshield - Hardcoated (715002432)
 - Soft Doors (715003402/715003470)
 - Soft Rear Panel (715003403)

Fits: UR (except MAX models)
715003401 - Mossy Oak Break-Up Country Camo

Fits: UR (MAX models only)
NEW 715003468 - Mossy Oak Break-Up Country Camo



100% MODULAR. IT'S YOUR CAB, YOUR WAY.

Can-Am's got a wide selection of components, so if you feel like designing your own cab, your own way, our modular system can make it happen. This is flexibility and versatility at work for you. Simply pick the windshield (p.103), doors (p.107), rear window (p.110) and roof (p.98) of your choice, and you're off. Whatever you choose to build your cab with we guarantee the components will work together, because they were designed to work together.

MAVERICK



SOFT CAB ENCLOSURE

- Offers good protection from the elements for driver and passenger.
- Complete with roof, sun visor, doors, and rear panel.
- Cannot be used with Snorkel Kit (715001728).

Included:

- Bimini Roof With Sun Visor (715001198/715001965)
- Soft Doors and Rear Panel (715003451/715003525)
- Full Windshield (715001786)

Fits: RS 2014 & up (except Turbo, X mr, X ds Turbo, X rs Turbo 2016 & up & MAX models)

■ 715003452 • Black

Fits: RS 2014 & up (MAX models except Turbo, X mr, X ds Turbo & X rs Turbo 2016 & up)

NEW ■ 715003453 • Black

SOFT DOORS & REAR PANEL

- Doors and rear panel are made of a solution dyed polyester Sur Last Series 70 for added durability.
- High UV, water and mildew resistance and has excellent tear and abrasion resistance.
- Windows are made of laminated polished vinyl material.
- Aluminum frame.
- Zip-Down windows.
- Quick and easy installation and easy to remove on hot and sunny days.
- Standard automotive type door opening.
- Can only be installed with Bimini Roof.
- Cannot be used with Snorkel Kit (715001728).

Fits: RS 2014 & up (except Turbo, X mr, X ds Turbo, X rs Turbo 2016 & up & MAX models)

■ 715003451 • Black

Fits: RS 2014 & up (MAX models except X mr, Turbo, X ds Turbo & X rs Turbo 2016 & up)

NEW ■ 715003525 • Black



COMMANDER



SOFT CAB ENCLOSURE

- Offers good protection from the elements for driver and passenger.
- Complete with roof, sun visor, doors, and rear panel.
- Cannot be used with the Snorkel Kit (715001728).
- Cannot be used with half windshields for Commander MAX Limited.

Included:

- Bimini Roof with Sun Visor (715001198/715001965)
- Soft Doors and Rear Panel (715002438/715002106)
- Full windshield (715001697)

Fits: RU 2014 & up (except MAX models)

■ 715003394 • Black

RU 2014 & up (MAX models only)

NEW ■ 715002105 • Black

SOFT DOORS & REAR PANEL

- Doors and rear panel are made of Series 70 Sur Last® solution-dyed polyester for added durability.
- High UV, water and mildew resistance, and excellent tear and abrasion resistance.
- Windows are made of laminated polished vinyl material.
- Aluminum frame.
- Zip-down windows.
- Quick and easy installation, and easy to remove on hot and sunny days.
- Standard automotive type door opening.
- Cannot be used with the Snorkel Kit (715001728).
- Cannot be used with half windshields for Commander MAX Limited.
- Can only be installed with Bimini Roof.

Fits: RU 2014 & up (except MAX models)

■ 715002438 • Black

Fits: RU 2014 & up (MAX models only)

NEW ■ 715002106 • Black





DEFENDER

SPORT ROOF

- Robust injection-molded polypropylene construction.
- Provides added protection for rider and passenger from the elements.

Fits: UR (except MAX models)

715002430

Fits: UR (MAX models only)

NEW 715003038



NEW

DELUXE SPORT ROOF

- (Not illustrated)
- Complete roof kit provides extra driver and passenger protection and also diminishes noise within the cab.
- Perfect fit and finish thanks to the seal kit and the liners included.
- Includes Sport Roof (715002430), Sport Roof Seal Kit (715003126), Front Roof Liner (715003098) and Rear Roof Liner (715003099).

Fits: UR (except MAX models)

715002511

Some products shown may not be available or homologated in your country. Contact your BRP dealer for local details.



NEW

BIMINI ROOF WITH SUN VISOR

- Innovative soft top comes with a hard visor which allows for storage of rolled-up soft top and permits the mounting of the Light Rack for Sport Visor.
- Offers good protection from the elements, falling debris and overhead obstacles, and excellent shade from sun and heat.

Fits: UR (MAX models only)

- UV-resistant, water-repellent and coated weather-tough fabric.

■ 715003030 - Black

- UV-resistant, water-repellent 600-denier coated fabric.

■ 715003469 - Mossy Oak Break-Up Country Camo



BIMINI ROOF WITH SUN VISOR

- Innovative soft top comes with a hard visor which allows for storage of rolled-up soft top and permits the mounting of the Light Rack for Sport Visor.
- Offers good protection from the elements, falling debris and overhead obstacles, and excellent shade from sun and heat.

Fits: UR (except MAX models)

- UV-resistant, water-repellent 600-denier solution-dyed polyester with Can-Am branding.
- Not compatible for use with soft and rigid full doors.

NEW ■ 715003418 - Black

- UV-resistant, water-repellent 600-denier coated fabric.

■ 715002849 - Mossy Oak Break-Up Country Camo



FRONT ROOF LINER

- Vehicle enhancement.
- Integrates seamlessly with roof-mounted light switch.
- Must be used for light installation on the roof.
- Must be used for radio and allows a better integration of Windshield Wiper and Washer Kit (715001638).

Fits: UR

715003098



NEW

REAR ROOF LINER

- Quick and easy vehicle enhancement.
- Allows better integration of other accessories installed on the roof.
- Needs to be installed with Sport Roof (715002430).

Fits: UR (except MAX models)

715003099



MAVERICK COMMANDER

SPORT ROOF

- Excellent protection from the elements.
- Can be assembled with Light Rack for Cage or Sport Roof.
- Easy and tool-less installation.

Fits: RS 2014 & up, RU 2014 & up

- Injected HDPE construction.

NEW ■■■ 715003020 • Black

Fits: RS, RU (except MAX models)

- Thermoformed TPO construction.

■■■ 715003061 • Mossy Oak Break-Up Country Camo

■■■ 715001444 • Next G-1 Vista Camo

■■■ 715001679 • Black



SPORT ALUMINUM ROOF

- Formed aluminum roof 2.25 mm thick.
- Durable and lightweight.
- Sporty look.
- Not compatible with full windshields (715001678, 715001697, 715001698, 715001786, 715001787).
- Not compatible with Intrusion Bar (715002979, 715002980, 715002863).

Fits: RS, RU (except MAX models)

715001659 • Bare Aluminum



MAVERICK COMMANDER

 CATCH THE VIDEO AT CAN-AMOFFROAD.COM



NEW

LONESTAR RACING ALUMINUM ROOF

- 0.083" (2.1 mm) thick aluminum roof.
- Durable and lightweight.
- Enhances the vehicle's racing appearance thanks to an authentic sporty look combined with unique eye-popping graphics.
- Not compatible with light racks and with full windshields.
- Offers you protection from the elements with a personalized touch.
- "Lonestar Racing for Can-Am" branded.

Fits: RS 2014 & up, RU 2014 & up (except MAX models)

■■■ 715003590 • Manta Green

■■■ 715003805 • Octane Blue

■■■ 715003806 • Can-Am Red

Fits: RS, RU (MAX models only)

■■■ 715003591 • Manta Green

■■■ 715003807 • Octane Blue

■■■ 715003808 • Can-Am Red



SPORT ROOF WITH SKYLIGHT

- Roof for protection against the elements without compromising exposure to natural outside light.
- Thermoformed TPO construction.
- Tinted skylight.
- Can be assembled with Light Rack for Sport Roof (715001686 or 715001094).

Fits: RS, RU (MAX models only)

■■■ 715001967 • Black

■■■ 715002504 • Light Grey

ROLL CAGE COVER

- Plastic cover shields roll cage.
- Gives a color accent and more a finished look.
- Standard on Maverick MAX X rs DPS and XT models.

Fits: RS, RU (MAX models only)

■■■ 705009840 • Octane Blue

■■■ 705009841 • Viper Red

■■■ 705008450 • Black

■■■ 705008976 • Can-Am Red

■■■ 705007956 • White

■■■ 705007955 • Yellow



MAVERICK COMMANDER



DELUXE CONVERTIBLE ROOF

- Ultimate in protection, style and integration.
- Twinsheet HDPE manufacturing delivers premium look, and complete coverage when combined with Sport Visor.
- Quick-attach bracket procures fast, easy and tool-less installation and removal.

Fits: RS 2013, RU 2011-2013 (except MAX models)

- 715001306 - Red
- 715001478 - Black
- 715001479 - Yellow

Fits: RS 2014 & up, RU 2014 & up (except MAX models)

- 715001951 - Red
- 715001949 - Black
- 715001950 - Yellow
- 715002503 - Light Grey

SPORT VISOR

- Twinsheet HDPE sport visor complete with integrated driver and passenger inner storage pockets.
- Required for installation of Light Rack (715001718 or 715001687).
- Complete with integrated light switch knock outs.
- Creates full roof for maximum element protection when combined with the Deluxe Convertible Roof.
- Easy installation and removal.
- Can be used in conjunction with any windshield.

Fits: RS 2013, RU 2011-2013

- Standard on Limited model.
- 715000762 - Black

Fits: RS 2014 & up, RU 2014 & up

- 715001952 - Black
- 715002502 - Light Grey

BIMINI ROOF WITH SUN VISOR

- Soft top with hard visor.
- Allows user to stow the soft top on the hard visor.
- Hard visor allows the possibility of installing the light rack.
- UV-resistant, water-repellent 600-denier solution-dyed polyester with Can-Am branding.

Fits: RS, RU (except MAX models)

715001198 - Black



NEW ■ 715001316 - Mossy Oak Break-Up Country Camo

Fits: RS, RU (MAX models only)

■ 715001965 - Black



CATCH THE VIDEO AT CAN-AMOFFROAD.COM

SOFT ROOF

- Provides protection from falling debris and overhead obstacles.
- UV-resistant, water-repellent 600-denier solution-dyed polyester with Can-Am branding.
- Velcro straps for quick and easy installation.
- Roof can be folded on the cage.
- Compatible with Light Rack for Cage or for Sport Roof (715001094, 715001686).
- Allows user to stow the soft top on the cage.

Fits: RS, RU (except MAX models)

715003395



MESH ROOF

- Provides protection from falling debris and overhead obstacles.
- UV-resistant with Can-Am branding.
- Velcro® straps for quick and easy installation.
- Allows user to stow the soft top on the cage.
- Compatible with Light Rack for Cage or for Sport Roof (715001094, 715001686).

Fits: RS, RU (except MAX models)

715003130



DEFENDER



NEW

FLIP GLASS WINDSHIELD WITH WIPER & WASHER KIT

- Curved and laminated glass full windshield in metal frame.
- Provides excellent optical clarity.
- Seals firmly against the cage and protects rider and passenger from the elements while allowing for controlled airflow.
- 3-position flip can be set at fully closed, ¼ open, or fully open.
- Ideal for muddy conditions.
- Gas-shock-assisted operation and pivots on 2 hinges located at the top of the windshield.
- Single-speed wiper with washer fluid dispenser.
- Requires Wiper and Power Cable (710004462) and Roof Power Cable (715003094).
- Not EC compliant.

Fits: UR

715002441



MUST HAVE

NEW

FLIP GLASS WINDSHIELD

- Curved and laminated glass full windshield in metal frame.
- Provides excellent optical clarity.
- Seals firmly against the cage and protects rider and passenger from the elements while allowing for controlled airflow.
- 3-position flip can be set at fully closed, ¼ open, or fully open.
- Gas-shock-assisted operation and pivots on 2 hinges located at the top of the windshield.
- Ideal for muddy conditions.
- Can be used with Windows Wiper & Washer Kit (715001638).
- Not EC compliant.

Fits: UR

715002942

NEW

WIPER AND POWER WINDOWS CABLE

- (Not illustrated)
- Required to install Full Doors with Power Windows (715001968) and/or Windshield Wiper and Washer Kit (715001638).
- Necessary if you want to build your own cab enclosure from modular components.

Fits: UR

710004462

NEW

WINDSHIELD WIPER AND WASHER KIT

- An ideal way to keep your windshield clear in rain, or while riding through mud and water.
- Includes single-speed wiper, washer fluid dispenser and windshield's frame mount.
- Must be used with the Glass Windshield (715001303) or Flip Glass Windshield (715002942).
- Requires Wiper and Power Windows Cable (710004462) and Roof Power Cable (715003094).
- Not EC compliant.

Fits: UR

715001638



DEFENDER



NEW

FLIP WINDSHIELD - HARDCOATED

- High-impact-resistant Makrolon hardcoated polycarbonate full windshield in metal frame.
- Provides excellent optical clarity and better abrasion resistance.
- Seals firmly against the cage and protects rider and passenger from the elements while allowing for controlled airflow.
- 3-position flip can be set at fully closed, ¼ open, or fully open.
- Gas-shock-assisted operation.
- Ideal for muddy conditions.

Fits: UR
715002442



NEW

GLASS WINDSHIELD

- Curved and laminated glass full windshield in metal frame.
- Seals firmly against the cage and protects rider and passenger from the elements while providing excellent optical clarity.
- Must be used with Windshield Wiper and Washer Kit (715001638) to maintain clear visibility during severe riding conditions, such as mud riding.
- Not EC compliant.

Fits: UR
715001303



FULL WINDSHIELD-HARDCOATED

- High-impact-resistant Makrolon hardcoated polycarbonate full windshield.
- Provides excellent optical clarity and better abrasion resistance.
- Protects driver and passenger from the elements.
- Quick and easy tool-less installation or removal.

Fits: UR
715002432



FULL WINDSHIELD

- High-impact-resistant durable polycarbonate full windshield.
- Formulated to be non-yellowing, non-crazing, non-cracking with excellent UV resistance and optical clarity.
- Protects driver and passenger from the elements.
- Quick and easy tool-less installation or removal.

Fits: UR
715002431

HALF WINDSHIELD

- High-impact-resistant durable polycarbonate half-windshield.
- Formulated to be non-yellowing, non-crazing, non-cracking with excellent UV resistance and optical clarity.
- Protects driver and passenger from the elements.
- Features reverse angle lip to deflect air flow.
- Quick and easy tool-less installation or removal.
- Not compatible with Soft Doors.

Fits: UR
715002433



MAVERICK COMMANDER

FLIP WINDSHIELD

- Made of thick 6 mm polycarbonate.
- 3-position flip can be set at fully closed, 1/4 open or 1/2 open.
- Allows rider to obtain the air flow of a half windshield with the protection of a full windshield without changing any parts.
- Top can be removed without tools.
- Windshield pivots on 2 fixed points on cage.
- Ideal for muddy conditions.

Fits: RS
715002465

Fits: RU
715002466



CATCH THE VIDEO AT CAN-AMOFFROAD.COM

HALF WINDSHIELD

- High-impact-resistant durable polycarbonate.
- Non yellowing, non crazing, non cracking with excellent UV resistance and optical clarity.
- Protects driver and passenger from the elements.
- Features reverse angle lip to deflect air flow.
- Quick-attach brackets procure fast, easy and tool-less installation and removal.
- Not compatible with Full Doors.

Fits: RS
715001653

Fits: RU
715001696

GLASS WINDSHIELD WITH WIPER & WASHER KIT

- Glass windshield with wipers and washer fluid dispenser.
- Metal frame with D.O.T. approved glass.
- Wide coverage (2 wipers).
- 2-speed wiper control.
- Windshield washer tank integrated in the vehicle service center.
- Requires power cable (715002036) for Commander MAX.
- Europe:**
- Not EC compliant.
- Requires Defrost, Heat and Ventilation System (715001390) for installation on EC homologated vehicles.

Fits: RU
715001678



FULL WINDSHIELD - HARDCOATED

- High-impact-resistant Makrolon hardcoated polycarbonate full windshield.
- Quick-attach brackets procure fast, easy and tool-less installation and removal.
- Provides excellent optical clarity and better abrasion resistance.
- Protects driver and passenger from the elements.

Fits: RS
715001787

Fits: RU
715001698



MUST HAVE

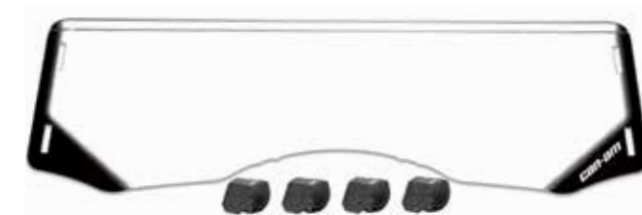

FULL WINDSHIELD

- High-impact-resistant polycarbonate full windshield.
- Non yellowing, non crazing, non cracking with excellent UV resistance and optical clarity.
- Quick-attach brackets procure fast, easy and tool-less installation and removal.
- Protects driver and passenger from the elements.

Fits: RS
715001786

Fits: RU
715001697

DEFENDER

SIDE MIRROR

- Molded heavy-duty aluminum mirror.
- Stays in place on rough trails.
- Ball-joint design for steady multi-angle adjustment and outstanding vision.
- Use with or without roof, or windshield.
- Not for road use.
- Fits either side.
- Sold individually.

Fits: UR
715002459



PANORAMIC CENTER MIRROR

- Wide-angle convex mirror.
- Offers enhanced visibility.
- Can be used with or without roof or windshield.

Fits: UR
715002512

MAVERICK COMMANDER

ALUMINUM SIDE MIRROR

- Molded heavy-duty aluminum mirror.
- Stays in place on rough trails.
- Ball-joint design for steady multi-angle adjustment and outstanding vision.
- Use with or without roof, or windshield.
- Not for road use.
- Fits either side.
- Not compatible with Cab Enclosure.
- Sold individually.

Fits: RS, RU
715002091



ALUMINUM CENTER REARVIEW MIRROR

- Molded heavy-duty central aluminum mirror.
- Stays in place on rough trails.
- Ball-joint design for steady multi-angle adjustment and outstanding vision.
- Not compatible with Light Rack for Cage or for Sport Roof (715001686, 715001094).
- Not for road use.

Fits: RS, RU
715002220



MIRROR FOR CAB ENCLOSURE

- Large mirror for better visibility.
- Sold in pairs.
- Full Doors (715001301) or Rigid Cab Enclosure (715001299) required for installation.

715002544



PANORAMIC CENTER MIRROR

- Convex mirror for wide angle visibility.
- Can be used with or without roof and windshields.

Fits: RS, RU
715000956



SIDE MIRROR

- Includes clamp for installation on cage.
- Not compatible with Cab Enclosure.

Fits: RS, RU

Left
715001192

Right
715001418



REARVIEW MIRROR

- Car-type mirror.
- Can be used with or without roof and windshields.
- Not compatible with Light Rack for Cage or for Sport Roof (715001686, 715001094).

Fits: RS, RU
715001191



DEFENDER



NEW

FULL DOORS WITH POWER WINDOWS

- Made from robust high-density polyethylene.
- Offer excellent protection from the elements.
- Easy to remove on hot and sunny days.
- Lockable doors with convenient integrated storage areas.
- Doors' curved-design provides even more roominess.
- Rear hinge wide opening for ease of ingress/egress in the cockpit.

Fits: UR
715001968

- Power window delivers added ventilation.
- Compatible with all BRP windshields.
- Require Wiper and Power Windows Cable (710004462) and Roof Power Cable (715003094).
- Sport Roof Seal Kit (715003126) is required.



NEW COMING SOON

HALF DOORS

- Half doors made of plastic.
- Metal frame for a higher level of fit and finish and rigidity.
- Rear hinge wide opening for ease of ingress/egress in the cockpit.
- Interior pockets and liners for more protection.

Fits: UR
715003029 • Sold in pairs
715003031 • Includes 4 doors



DEFENDER

SOFT DOORS

- Steel-reinforced frame.
- Offer good protection from the elements.
- Rear hinge wide opening for ease of ingress/egress in the cockpit.
- Zippered windows for added ventilation.
- Easy to remove on hot and sunny days.
- Compatible with all BRP roofs, windshields, and mirrors.
- Not compatible with half windshield.

Fits: UR (except MAX models)

- Coated weather-tough and water-repellent fabric.

■ 715002919 • Black

- 600-denier weather-tough and water-repellent fabric.

■ 715003402 • Mossy Oak Break-Up Country Camo

Fits: UR (MAX models only)

- Coated weather-tough and water-repellent fabric.

NEW ■ 715003033 • Black

- 600-denier weather-tough and water-repellent fabric.

NEW ■ 715003470 • Mossy Oak Break-Up Country Camo



MAVERICK COMMANDER

SPORT ALUMINUM DOORS

- Made of lightweight aluminum.
- Rotary latch and rear hinge wide opening for ease of ingress/egress in the cockpit.
- Powder coated black.

Fits: RS 2013, RU 2011-2013

715001658

Fits: RS, RU 2014 & up

715002115

Fits: RS, RU (MAX models only)

715001958



PADDED STORAGE FOR SPORT ALUMINUM DOORS

- Padded door cushion with integrated pocket for storage.
- Protects driver and passenger legs from banging against doors during ride.
- Offers storage space for small items.

Fits: RS, RU 2014 & up

715002351 • Front

Fits: RS, RU (MAX models only)

715002405 • Rear



COMMANDER



FULL DOORS

- Made from durable polyethylene.
- Sliding side glass window for better ventilation.
- Lockable doors.
- Provide the best protection from the elements.
- Compatible with Sport and Deluxe Roofs.
- Keep you warm on cold days.
- Easy to remove on hot and sunny days.
- Can be used with glass windshield or full polycarbonate windshield.
- Do not fit with Bimini Roof, Rear Nets and Flip Windshield.

Fits: RU 2014 & up (except MAX models)

715001301





DEFENDER



REAR WIND SCREEN

- Black full rear mesh reduces windshield backdraft.
- Roll-bar mounted.
- Can-Am branded.

Fits: UR
715002851



SOFT REAR WINDOW

- Clear, flexible window made from transparent vinyl.
- Resists cold-cracking to -4°F (-20°C).

- Ideal for preventing backdraft of dust or rain in harsh environments.
- Velcro straps for quick and easy installation.

Fits: UR
715003249



REAR GLASS WINDOW

- Made of high-strength tempered glass.
- Ideal for preventing backdraft of dust or rain in harsh environments.

- Quick and easy tool-less installation.
- Sport Roof (715002430 or 715003038) required for installation.

Fits: UR
715003009



REAR POLYCARBONATE WINDOW

- High-impact-resistant polycarbonate window.
- Ideal for preventing backdraft of dust or rain in harsh environments.

- Quick and easy tool-less installation.
- Sport Roof (715002430 or 715003038) required for installation.

Fits: UR
715002922

DEFENDER

NEW

REAR GLASS WINDOW WITH SLIDING PANEL

- Made of high-strength tempered glass.
- Ideal for preventing backdraft of dust or rain in harsh environments.
- Sliding panel for enhanced ventilation.
- Quick and easy tool-less installation.
- Sport Roof (715002430 or 715003038) required for installation.

Fits: UR
715002440



SOFT REAR PANEL

- Offers good protection from the elements.
- Resists cold-cracking to -22 °F (-30 °C).
- Compatible with all BRP roofs and doors.
- Easy-to-remove when installed with Bimini Roof.
- Steel-reinforced frame.

Fits: UR
• Coated weather-tough and water-repellent fabric.
■ 715002920 • Black

• 600-denier weather-tough and water-repellent fabric.
■ 715003403 • Mossy Oak Break-Up Country Camo



MAVERICK COMMANDER



REAR WIND SCREEN

- Full rear mesh coverage reduces windshield backdraft.
- Roll-bar mounted.
- White Can-Am logo on black mesh.
- Not Snorkel Kit compatible.
- Standard on Limited model.

Fits: RS (Turbo, X ds Turbo & X rs Turbo 2016 & up models only)
715002552

Fits: RS (except Turbo, X ds Turbo & X rs Turbo 2016 & up models), RU
715003078



SOFT REAR WINDOW

- Clear soft window made from see-through vinyl with cold cracking resistance to temperatures down to -4°F (-20°C).
- Prevents dust and rain from drafting back into the vehicle in harsh riding environments.
- Quick installation with 2" (5 cm) Velcro straps.

Fits: RS 2013, RU 2011-2013 (except MAX models)
715001373

Fits: RS 2014 & up (except X mr, Turbo, X ds Turbo, X rs Turbo 2016 & up models),
RU 2014 & up
715003131



REAR WINDOW

- Durable polyethylene frame and polycarbonate window.
- Quick and easy installation.
- Protects rear of cabin, like the rear windshield on a car.
- Same model as in Cab Enclosure.
- Not compatible with Harness Bars (715002953, 715002954, 715002955 and 715002535).
- Compatible with Gear Rail.

Fits: RS 2014 & up (except Turbo, X mr, X ds Turbo, X rs Turbo 2016 & up & MAX models)
715002856

Fits: RU 2014 & up (except MAX models)
715001300

Fits: RU (MAX models only)
715002119

Fits: RS (MAX models only except X mr, X ds Turbo, X rs Turbo 2016 & up)
715002857



REAR WINDOW NET

- Net designed to look sharp.
- Rally / Race inspired design.
- Installs in a snap.
- 2" (5 cm) Velcro straps.
- Mounts to roll over protective cage.

Fits: RS 2013, RU 2011-2013
715000832 - Black

Fits: RS 2014 & up (except X ds Turbo),
RU 2014 & up
715003132

DEFENDER

ALUMINUM SKID PLATES

For ultimate durability and strength, all our Aluminum Skid Plates are made with High Strength 5052 H32 Aluminum 3/16" (4.5 mm) thick.

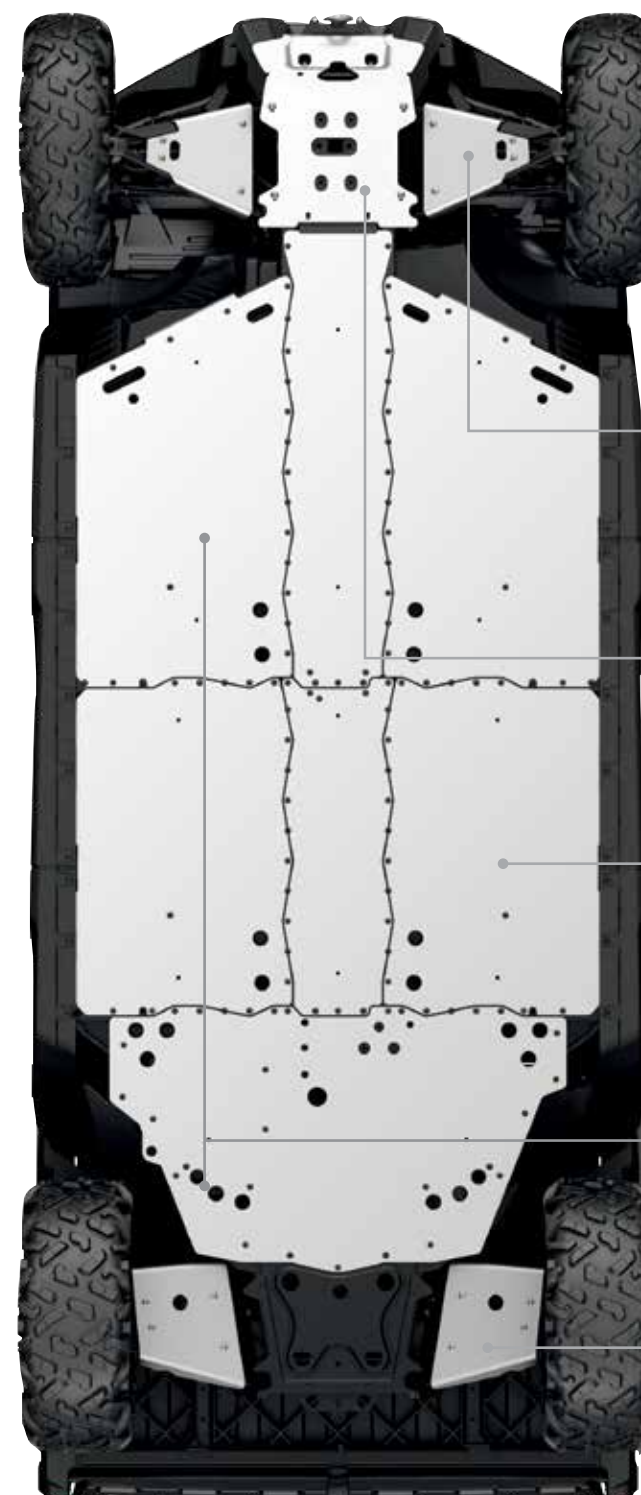

UR (MAX models only)

UR (except MAX models)

ALUMINUM SKID PLATE PROTECTION KIT

INCLUDES:

- Front A-Arm Protectors
- Front Skid Plate
- Underbelly Skid Plate Kit
- Rear A-Arm Protectors
- Central Skid Plate

715003712

715003711

INDIVIDUAL ALUMINUM SKID PLATES

FRONT A-ARM PROTECTORS

- Extra underside protection for your vehicle's steering mechanism and suspension (A-Arm).
- Can-Am branded.
- Sold in pairs.

715002444

715002444

FRONT SKID PLATE

- Protects the front underside of your vehicle when riding in rough terrain conditions.
- Adds style to the front of your vehicle.
- Can-Am branded.

715002447

715002447

CENTRAL SKID PLATE

- Central skid plate kit includes central and lateral skid plates.
- Ultra-durable protection for the underside of your vehicle.
- Makes work easy in more demanding terrain.
- Must be used with Underbelly Skid Plate Kit (715002446).
- For MAX models only.

NEW
715003467

UNDERBELLY SKID PLATE KIT

- Ultra-durable protection for the underside of your vehicle.
- Makes work easy in more demanding terrain.
- Kit includes central, lateral and rear skid plates.

715002446

715002446

REAR A-ARM PROTECTORS

- Extra underside protection for your vehicle's suspension (A-Arm).
- Can-Am branded.
- Sold in pairs.

715002445

715002445

Some products shown may not be available or homologated in your country. Contact your BRP dealer for local details.

MAVERICK

HMWPE SKID PLATES

Lighter than aluminum. 3/8" (9.5 mm) High Molecular Weight Polyethylene (HMWPE) that glides smoothly and silently over obstacles.

CATCH THE VIDEO AT CAN-AMOFFROAD.COM

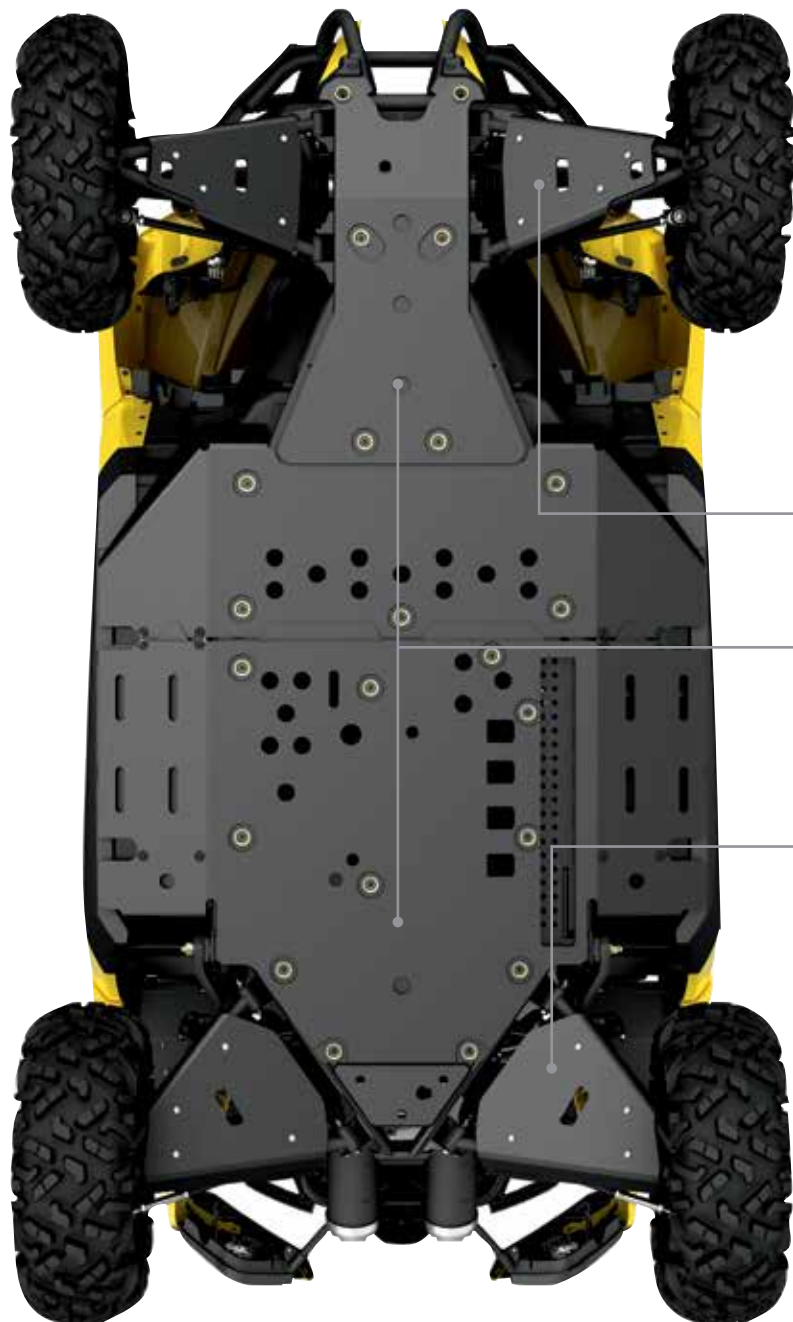

FIND YOUR PLATFORM

RS, RS X RS, RS X MR 2015 & PRIOR (EXCEPT MAX MODELS)	RS, RS X RS 2015 & PRIOR (MAX MODELS ONLY)	RS X XC, RS X C (EXCEPT MAX MODELS)	RS X DS, RS X RS 2016 & UP
---	--	-------------------------------------	----------------------------

HMWPE PLASTIC SKID PLATE PROTECTION KIT

INCLUDES: • Front A-Arm Protectors • Rear A-Arm Protectors • Underbelly Plates

NEW
715004208

INDIVIDUAL HMWPE PLASTIC SKID PLATES

FRONT A-ARM PROTECTORS

715002100	715002100	715002100
-----------	-----------	-----------

UNDERBELLY PLATES

• Includes front, central and rear skid plates.

715002109	715002109
-----------	-----------

REAR A-ARM PROTECTORS

715002101	715002101
-----------	-----------

MAVERICK

ALUMINUM SKID PLATES

For ultimate durability and strength all our Aluminum Skid Plates are made with High Strength 5052 H32 Aluminum 3/16" (4.5 mm) thick.

Maverick MAX illustrated



FIND YOUR PLATFORM

RS, RS X RS 2015 & PRIOR (EXCEPT MAX & X MR MODELS)	RS, RS X RS 2015 & PRIOR (MAX MODELS ONLY)	RS X DS, ALL TURBO MODELS (EXCEPT MAX MODELS)	RS X XC, RS XC (EXCEPT MAX MODELS)	RS X DS, RS X RS 2016 & UP (EXCEPT MAX MODELS)	RS X DS, RS X RS 2016 & UP (MAX MODELS ONLY)
---	--	---	------------------------------------	--	--

ALUMINUM SKID PLATE PROTECTION KIT

INCLUDES: • Front A-Arm Protectors • Front Skid Plate • Rear Skid Plates
• Lateral Central Skid Plates (MAX only) • Rear Lateral Skid Plates • Rear A-Arm Protectors
• Central Skid Plate (MAX only)

715002131	715002132	715003127 (Turbo)	715002294	715002514	715002558
				715003127 (Turbo)	715003313 (Turbo)

INDIVIDUAL ALUMINUM SKID PLATES

FRONT A-ARM PROTECTORS

• Sold in pairs. • Can-Am logo.

715001639	715001639	715001639	715002021	715001639	715001639
-----------	-----------	-----------	-----------	-----------	-----------

FRONT SKID PLATE

• Can-Am logo.

715001641	715001641	715001641	715001641	715001641	715001641
-----------	-----------	-----------	-----------	-----------	-----------

CENTRAL SKID PLATE - MAVERICK MAX ONLY (INCLUDED IN COMPLETE KIT)

• Can-Am logo.

715001969					715001969
-----------	--	--	--	--	-----------

LATERAL CENTRAL SKID PLATES - MAVERICK MAX ONLY (INCLUDED IN COMPLETE KIT)

• Sold in pairs. • Can-Am logo.

715001970					715001970
-----------	--	--	--	--	-----------

FRONT LATERAL SKID PLATES

• Sold in pairs. • Can-Am logo.

715002494	715002494	715002494	715002494	715002494	715002494
-----------	-----------	-----------	-----------	-----------	-----------

REAR LATERAL SKID PLATES

• Sold in pairs. • Can-Am logo.

715001640	715001640	715003128 (Turbo)	715001640	715001640	715001640
				715003128 (Turbo)	715003128 (Turbo)

REAR SKID PLATES

• Can-Am logo.

715001643	715001643	715002515	715001643	715002515	715002515
-----------	-----------	-----------	-----------	-----------	-----------

REAR A-ARM PROTECTORS

• Sold in pairs. • Can-Am logo.

715001644	715001644	715002516	715002022	715002516	715002516
-----------	-----------	-----------	-----------	-----------	-----------

Some products shown may not be available or homologated in your country. Contact your BRP dealer for local details.

COMMANDER

ALUMINUM SKID PLATES

For ultimate durability and strength all our Aluminum Skid Plates are made with High Strength 5052 H32 Aluminum 3/16" (4.5 mm) thick.

Commander MAX illustrated

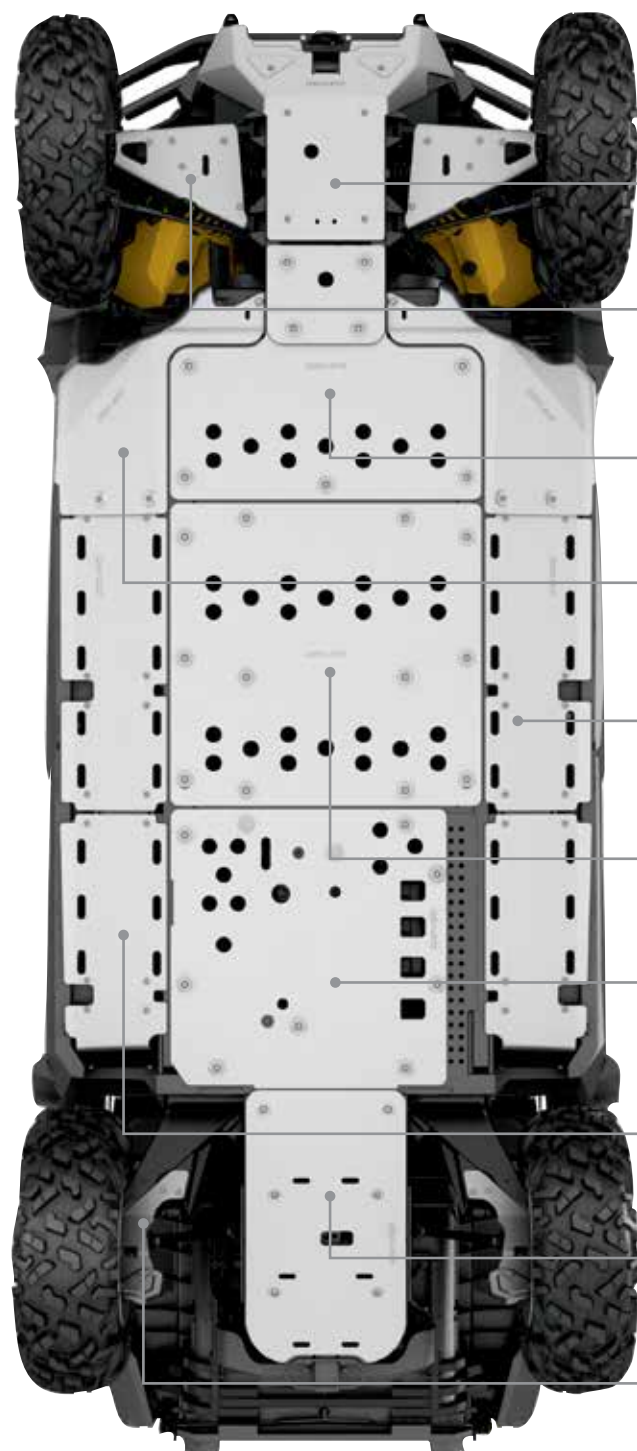

FIND YOUR PLATFORM

RU 2015 & UP (EXCEPT MAX MODELS)	RU 2011-2014 (EXCEPT MAX MODELS)	RU (MAX MODELS ONLY)
---	---	---------------------------------

ALUMINUM SKID PLATE PROTECTION KIT

INCLUDES:	• Front Skid Plate • Central Skid Plate	• A-Arm Protectors • Rear Skid Plate	• Front Lateral Skid Plates • Trailing Arm Protectors
715002735	715002130	715002133	

INDIVIDUAL ALUMINUM SKID PLATES

FRONT SKID PLATE

• Can-Am logo.	715000692	715000692	715000692
----------------	-----------	-----------	-----------

A-ARM PROTECTORS

• Aluminum A-arm plates and plastic deflectors provide essential protection and aggressive look.	• Sold in pairs. • Can-Am logo.	715000660	715000660	715000660
--	------------------------------------	-----------	-----------	-----------

FRONT CENTRAL SKID PLATE

• Can-Am logo.	715001996	715001996	715001996
----------------	-----------	-----------	-----------

FRONT LATERAL SKID PLATES

• Sold in pairs.	• Can-Am logo.	715002494	715000950	715002494
------------------	----------------	-----------	-----------	-----------

LATERAL CENTRAL SKID PLATES

- COMMANDER MAX ONLY (INCLUDED IN COMPLETE KIT)			
• Sold in pairs.	• Can-Am logo.		715001970

CENTRAL SKID PLATE - COMMANDER MAX ONLY (INCLUDED IN COMPLETE KIT)

• Can-Am logo.			715001969
----------------	--	--	-----------

CENTRAL SKID PLATE

• Pre-cut holes for fluid and mud drainage, and servicing access.	• Can-Am logo. • Direct replacement of factory installed plastic skid.	715001997	715000693	715001997
---	---	-----------	-----------	-----------

REAR LATERAL SKID PLATES

• Sold in pairs.	• Can-Am logo.	715001640		715001640
------------------	----------------	-----------	--	-----------

REAR SKID PLATE

• Direct replacement of factory installed plastic skid.	• Can-Am logo.	715000694	715000694	715000694
---	----------------	-----------	-----------	-----------

TRAILING ARM PROTECTORS

• Sold in pairs.	715000661	715000661	715000661
------------------	-----------	-----------	-----------



DEFENDER

NEW

RANCHER BUMPER

- Heavy-duty, rugged look.
- Front protection for farm, ranch and forestry applications.
- Low front end protection and plates for Side-by-side use in cattle herds.
- Protects both vehicle and the animals.
- Headlight protection.
- Full front coverage.
- Inside and outside anti-corrosion coating with durable powder coat finish.
- Not compatible with Apache 360 LT Track System (715003064).
- Not compatible with Super-Duty Plow Kit (715003416), with or without Super-Duty Plow Hydraulic Angling Kit (715002840).
- Compatible with Alpine Flex Plow Kit (715003108).

Fits: UR
715002834





DEFENDER



REAR BUMPER

- Heavy-duty 1.5" (3.8 cm) diameter steel construction and integrated tubular design.
- Increased protection of rear box and lower box corner while allowing normal tailgate function.
- Integrated steps.
- Inside and outside anti-corrosion coating with durable powder coat finish.
- Required to install Rear Body Side Protector (715003055).

Fits: UR
715002419



XTREME FRONT BUMPER PLATES

- Made of high-strength heavy-gauge steel with rubber pads for increased protection.
- Inside and outside anti-corrosion coating with durable powder coat finish.
- Provide additional front-end protection.
- Require Front Bumper (715002418) for installation.

Fits: UR
715003005

DEFENDER



FRONT BUMPER

- Heavy-duty 1.5" (3.8 cm) diameter steel-tube construction.
- Provides enhanced protection.
- Inside and outside anti-corrosion coating with durable powder coat finish.
- Light-kit compatible.
- Required to install the following accessories: Xtreme Front Bumper (715003005) and Front Corner Protectors (715002833).

Fits: UR
715002418

FRONT CORNER PROTECTORS

- Heavy-duty 1.25" (3.2 cm) diameter steel-tube construction.
- Provide enhanced protection for front corners.
- Inside and outside anti-corrosion coating with durable powder coat finish.
- Require Front Bumper (715002418) for installation.
- Sold in pairs.

Fits: UR
715002833



REAR BODY SIDE PROTECTORS

- Heavy-duty 1.5" (3.8 cm) diameter steel-tube construction.
- Reliable cargo box protection.
- Inside and outside anti-corrosion coating with durable powder coat finish.
- Integrated brush and low-lying branch deflector.
- Require Rear Bumper (715002419) for installation.
- Compatible with Fender Flare (715002424).
- Sold in pairs.

Fits: UR
715003055



FENDER FLARE

- Robust injection-molded polypropylene construction.
- Perfect for keeping mud and debris outside the vehicle.
- Includes front and rear extension, and all mounting hardware.

Fits: UR
715002424

DEFENDER



NEW

FRONT BODY SIDE PROTECTORS

- Heavy-duty 1.25" (3.2 cm) diameter steel-tube construction.
- Inside and outside anti-corrosion coating with durable powder coat finish.
- Front side protection for farm, ranch and forestry applications.
- Require Front Bumper (715002418) with Front Corner Protectors (715002833) and Rock Sliders (715002569) or Rock Sliders (715003040 for MAX models) for installation.
- Offer complete front body protection.
- Sold in pairs.

Fits: UR
715003450



NEW

FRONT RANCHER BODY SIDE PROTECTORS

- Heavy-duty 1.25" (3.2 cm) diameter steel-tube construction.
- Inside and outside anti-corrosion coating with durable powder coat finish.
- Front side protection for farm, ranch and forestry applications.
- Require Rancher Bumper (715002834) and Rock Sliders (715002569) or Rock Sliders (715003040 for MAX models) for installation.
- Offer complete front body protection.
- Sold in pairs.

Fits: UR
715003617

NEW

ROCK SLIDERS

- Protect vehicle's sides and undercarriage against large obstacles.
- Made of heavy-duty 1.5" (3.8 cm) diameter steel tubing.
- Inside and outside anti-corrosion coating with durable powder coat finish.
- Integrated step for easy cargo box access.
- Sold in pairs.

Fits: UR (except MAX models)
715002569 - Black

Fits: UR (MAX models only)
715003040 - Black



NEW

MUD FLAPS

- Keep mud and debris out of cargo area and protect trailer or vehicles behind you.
- Add aesthetic appeal to your vehicle.
- Made of EPDM rubber.
- Require Rear Bumper (715002419) for installation.
- Sold in pairs.

Fits: UR
715003041



DEFENDER

NEW FOR **S3** *can-am*

COMING SOON

S3 FRONT WINCH BUMPER

- Made of 1.5" (3.8 cm) diameter steel tubing with durable powder coat finish.
- Specifically developed for mud riding enthusiasts.
- Mounting location for clamped lights.
- Integrated mounting plates accommodate all winches.
- Added body protection.

- Allows higher winch position to avoid winch immersion in mud.
- Not compatible with LinQ Front Rack, Removable Winch Mounting Kit, Super-Duty Plow Push Frame Extension and Plow Pulley.
- "S3 for Can-Am" branded.

Fits: UR
 715003779 - Black
 715004151 - Combustion Blue



NEW FOR **S3** *can-am*

COMING SOON

S3 REAR WINCH BUMPER

- Made of 1.5" (3.8 cm) diameter steel tubing with durable powder coat finish.
- Specifically developed for mud riding enthusiasts.
- Integrated mounting plates for winches and towing anchor points.

- Added body protection.
- Not compatible with Apache 360 LT Track System and Removable Winch Mounting Kit.
- "S3 for Can-Am" branded.

Fits: UR
 715003782 - Black
 715004130 - Combustion Blue



NEW FOR **S3** *can-am*

COMING SOON

S3 NERF BARS

- Made of 1.5" (3.8 cm) diameter steel tubing with durable powder coat finish.
- Specifically developed for mud riding enthusiasts.
- Protect vehicle's lower sides without affecting ground clearance.

- Integrated step makes ingress easier.
- Not compatible with Front Body Side Protectors, Front Rancher Body Side Protectors and Apache 360 LT Track System.
- "S3 for Can-Am" branded.

Fits: UR (except MAX models)
 715003783 - Black
 715004131 - Combustion Blue





DragonFire
FOR *can-am*

DEFENDER



DragonFire
FOR *can-am*

NEW

DRAGONFIRE FRONT BUMPER

- 1.5" (3.8 cm) diameter steel tubing with durable powder coat finish.
- Delivers additional front protection.
- Rugged look and perfectly contoured to match vehicle's line.
- Integrated mounting plates for the 10" (25 cm) Double Stacked LED Light Bar (60 watts), the 4" (10 cm) Round LED Lights (2 x 25 watts), the HID or Halogen Lights by Hella.
- Not compatible with Removable Winch Mounting Kit, Drop Tow Bar, Higher Front Receiver Hitch, Front and Rear Hitch Drawbar, LinQ Front Rack, Super-Duty Plow Push Frame Extension, Plow Pulley and 15" (38 cm) Double Stacked LED Light Bar (90 watts).
- "DragonFire for Can-Am" branded.

Fits: UR

- 715003926 - Black
- 715004168 - Squadron Green



DragonFire
FOR *can-am*

NEW

DRAGONFIRE FRONT EXO-FRAME

- 1.5" (3.8 cm) diameter steel tubing with durable powder coat finish.
- Full front-corner side-body and headlight protection.
- Rugged look and perfectly contoured to match vehicle's line.
- Mounting point allows the installation of a round-format light at roll cage base.
- DragonFire Bumper required for installation.
- Sold in pairs.
- "DragonFire for Can-Am" branded.

Fits: UR

- 715003928 - Black
- 715004170 - Squadron Green

DEFENDER



DragonFire
FOR *can-am*

NEW

DRAGONFIRE SIDE RUNNERS

- 1.25" (3.2 cm) diameter steel tubing with durable powder coat finish.
- Protects vehicle's lower side without affecting ground clearance.
- Rugged look and perfectly contoured to match vehicle's line.
- Slotted steel plate step provides extra grip and makes vehicle's access easier.
- Offer full side protection combine with DragonFire Front & Rear Exo-Frame.
- Sold in pairs.
- "DragonFire for Can-Am" branded.

Fits: UR (except MAX models)

- 715003930 - Black
- 715004172 - Squadron Green

DragonFire
FOR *can-am*

NEW

DRAGONFIRE REAR EXO-FRAME

- 1.25" (3.2 cm) diameter steel tubing with durable powder coat finish.
- Full cargo bed side-wall impact protection.
- Rugged look and perfectly contoured to match vehicle's line.
- Sold in pairs.
- Complement with DragonFire Rear Bumper for full rear protection.
- "DragonFire for Can-Am" branded.

Fits: UR

- 715003929 - Black
- 715004171 - Squadron Green



DragonFire
FOR *can-am*

NEW

DRAGONFIRE SPARE TIRE HOLDER

- 1.5" (3.8 cm) diameter steel tubing with durable powder coat finish.
- Easy-to-install convenient cargo bed spare-tire mount (tire not included).
- Requires the DragonFire Cargo Bed Roll Bar.
- "DragonFire for Can-Am" branded.

Fits: UR (except on Mossy Oak models)

- 715003931 - Black
- 715004173 - Squadron Green



DragonFire
FOR *can-am*

NEW

DRAGONFIRE CARGO BED ROLL BAR

- 1.75" (4.4 cm) diameter steel tubing with durable powder coat finish.
- Helps protect cab components from cargo load.
- Rugged look and perfectly contoured to match vehicle's line.
- Required to install the DragonFire Spare Tire Carrier.
- Not to be used as a base for mounting lights.
- Not compatible with Rear Cargo Light.
- "DragonFire for Can-Am" branded.

Fits: UR

- 715003925 - Black
- 715004167 - Squadron Green



DragonFire
FOR *can-am*

NEW

DRAGONFIRE REAR BUMPER

- 1.5" (3.8 cm) diameter steel tubing with durable powder coat finish.
- Rugged look and perfectly contoured to match vehicle's line.
- Integrated step provides easy cargo bed access even when the tailgate is up.
- Not compatible with Mud Flaps.
- "DragonFire for Can-Am" branded.

Fits: UR

- 715003927 - Black
- 715004169 - Squadron Green



MAVERICK

CATCH THE VIDEO AT CAN-AMOFFROAD.COM



NEW

LONESTAR RACING FRONT BUMPER

- Made of 1.5" (3.8 cm) diameter steel tubing with durable powder coat finish with a 1/8" (3 mm) aluminum plate for extra durability.
- Delivers additional heavy-duty protection in extreme driving conditions.
- Enhances the racing look of the vehicle while adding extra protection.
- Features Lonestar Racing logos on the aluminum plate and tubing.
- Compatible with Front Bumper Lights.
- Not winch compatible.
- "Lonestar Racing for Can-Am" branded.
- Not EC compliant.

Fits: RS

- 715003594 • Octane Blue
- 715003773 • Can-Am Red
- 715003593 • Manta Green



NEW

LONESTAR RACING REAR BUMPER

- Made of 1.5" (3.8 cm) diameter steel tubing with durable powder coat finish.
- Protects vehicle bodywork and exhaust system.
- Enhances the racing look of the vehicle while adding extra protection.
- Required to install Lonestar Racing Rear Intrusion Bar and to complete full rear protection package.
- Not compatible with winch, hitch and Baja-Style Spare Tire Holder.
- "Lonestar Racing for Can-Am" branded.
- Not EC compliant.

Fits: RS (except Turbo, X ds, X ds Turbo, & X rs Turbo 2016 & up models)

- 715003602 • Octane Blue
- 715003804 • Can-Am Red
- 715003601 • Manta Green

Fits: RS (Turbo, X ds Turbo, X rs Turbo 2016 & up)

- 715003612 • Manta Green
- 715003613 • Octane Blue

MAVERICK



NEW

LONESTAR RACING FRONT INTRUSION BAR

- Made of 1.5" (3.8 cm) diameter steel tubing with durable powder coat finish.
- Enhances the racing look of the vehicle while adding extra protection.
- Matches vehicle styling.
- Compatible with Lonestar Racing Aluminum Roof.
- Not compatible with Aluminum Roof, Sport Visor and Light Rack.
- "Lonestar Racing for Can-Am" branded.

Fits: RS, RU

- 715003596 • Octane Blue
- 715003603 • Can-Am Red
- 715003595 • Manta Green



NEW

LONESTAR RACING REAR INTRUSION BAR

- Made of 1.5" (3.8 cm) diameter steel tubing with durable powder coat finish.
- Enhances the racing look of the vehicle while adding extra protection.
- Matches vehicle styling.
- Not compatible with Rear Window (715002856).
- "Lonestar Racing for Can-Am" branded.
- Requires assorted Lonestar Rear Bumper for installation.

Fits: RS (except MAX models)

- 715003600 • Octane Blue
- 715003803 • Can-Am Red
- 715003599 • Manta Green

Fits: RS (MAX models only)

- 715003598 • Octane Blue
- 715003802 • Can-Am Red
- 715003597 • Manta Green



MAVERICK



FRONT PRE-RUNNER BUMPER

- Made of 1.5" (3.8 cm) diameter steel tube with a 1/8" (3 mm) aluminum plate for extra durability.
- Added heavy-duty protection in extreme conditions.
- Mounting points for lights.
- Requires Mounting Plate for Winch installation (715001699 or 705203196 for Maverick X mr).
- Not EC compliant.

Fits: RS

- 715002525 - Octane Blue
- 715002526 - Can-Am Red
- 715002520 - Manta Green
- 715001645 - Black



DUNE FRONT BUMPER

- Made of 1.5" (3.8 cm) diameter steel tube with a 1/8" (3 mm) aluminum plate for extra durability.
- Delivers additional heavy-duty protection in extreme conditions.
- Features a more pronounced attack angle and mounting points for lights.
- Not winch compatible.
- Not EC compliant.

Fits: RS

- 715001954 - Black

MAVERICK

REAR BUMPER

- Extra-durable 1.5" (3.8 cm) diameter steel tube with a 1/8" (3 mm) aluminum plate.
- Sporty look.
- Protects vehicle bodywork and exhaust system.
- Rear receiver hitch compatible.
- Required for Baja-Style Spare Tire Holder installation.
- Not EC compliant.

Fits: RS (except Turbo, X ds, Turbo X ds, & X rs Turbo 2016 & up models)

- 715002527 - Octane Blue
- 715002528 - Can-Am Red
- 715002529 - Manta Green
- 715001646 - Black



X DS REAR BUMPER

- Extra-durable 1.5" (3.8 cm) diameter steel tubing with a 1/8" (3 mm) aluminum plate.
- Sporty look.
- Protects vehicle bodywork and exhaust system.
- Rear receiver hitch compatible.
- Baja-Style Spare Tire Holder compatible.
- Does not fit with EC homologated models.

Fits: RS (Turbo, X ds, X ds Turbo & X rs Turbo 2016 & up models only)

- 715002947 - Octane Blue
- 715002497 - Manta Green



TAIL LIGHT PROTECTORS

- Anti-corrosion coating with durable powder coat finish.
- Rugged style, aggressive look.
- Sold in pairs.

Fits: RS

- 715002982 - Octane Blue
- 715002981 - Can-Am Red
- 715002864 - Manta Green
- 715002506 - Black

MAVERICK COMMANDER



INTRUSION BAR

- Matches vehicle styling.
- Not windshield compatible.
- Steel intrusion bar.
- Not compatible with Aluminum Sportroof, Sport Visor and Light Rack.

Fits: RS, RU

- 715002980 - Octane Blue
- 715002979 - Can-Am Red
- 715002863 - Manta Green
- 715002505 - Black



BAJA-STYLE SPARE TIRE HOLDER

- Durable 1.5" (3.8 cm) diameter steel tubing.
- Holds spare tire in place.
- Custom tie-down strap for fast tire installation or removal.
- Compatible with the Wheel Jack (715001719).
- Rear Bumper required for installation.
- Wheel not included.

Fits: RS

- 715002957 - Octane Blue
- 715002956 - Can-Am Red
- 715002539 - Manta Green
- 715002011 - Black



WHEEL JACK

- ProArmor® Quickshot Wheel Jack.
- Helps you change a flat out on the trail.
- Includes a large base for more stability, even in soft soil.
- Includes 17 mm key for ease of wheel removal.
- Fits on Baja-Style Tire Holder.
- Can sit in Commander and Defender bed.
- Wheel not included.

Fits: RS, RU (in Commander bed only), UR (except MAX models)

- 715001719 - Black



MAVERICK COMMANDER



4-POINT HARNESS

- This 4-point harness uses 2" (5 cm) shoulder and hip straps and an automotive style buckle.
- Sewn-on shoulder pads and a leather pad on hips keep you comfortable.

Fits: RS 2014 & up (except X mr models), RU 2014 & up
715000736 • Driver

715002010 • Passenger

- A removable upper mounting point maintains the removable seat feature.
- Requires 4-point harness bar.
- Not EC compliant.



4-POINT HARNESS BAR - 2-UP AND REAR SEAT OF MAX MODELS

- 1.5" (3.8 cm) diameter, thick-walled steel tubing.
- Designed for use with Can-Am 4-Point Harness (715000736 (driver) and 715002010 (passenger)).
- Not EC compliant.

Fits: RS 2014 & up (except X mr models), RU

- 715002954 • Octane Blue
- 715002955 • Can-Am Red
- 715002535 • Manta Green
- 715002953 • Black



4-POINT HARNESS BAR - FRONT SEAT ON MAX MODELS

- 1.5" (3.8 cm) diameter, thick-walled steel tubing.
- Designed for use with Can-Am 4-Point Harness (715000736 (driver) and 715002010 (passenger)).
- Includes bar foam and covers.
- Not EC compliant.

Fits: RS (MAX models except X mr), RU (MAX models only)

- 715002952 • Octane Blue
- 715002951 • Can-Am Red
- 715002541 • Manta Green
- 715002069 • Black



MAVERICK COMMANDER

SPORT ROCK SLIDERS FOR MAX

- Protects vehicle's sides and undercarriage against large obstacles.
- Made of heavy-duty 1.5" (3.8 cm) diameter steel tube.
- Anti-corrosion coating with durable powder coat finish.
- Sold in pairs.

Fits: RS, RU (MAX models only)

- 715002943 • Octane Blue
- 715002944 • Can-Am Red
- 715002540 • Manta Green
- 715002088 • Black



SPORT ROCK SLIDERS

- Protects vehicle's sides and undercarriage against large obstacles.
- Made of heavy-duty 1.5" (3.8 cm) diameter steel tube.
- Anti-corrosion coating with durable powder coat finish.
- Sold in pairs.

Fits: RS, RU (except MAX models)

- 715002532 • Manta Green
- 715001649 • Black



ROCK SLIDERS

- Protects vehicle's sides and undercarriage against large obstacles.
- Made of heavy-duty 1.5" (3.8 cm) diameter steel tube.
- Anti-corrosion coating with durable powder coat finish.
- Standard on XT-P models.
- Sold in pairs.

Fits: RS, RU (except MAX models)

- 715003125 • Octane Blue
- 715003124 • Can-Am Red
- 715003123 • Manta Green
- 715001722 • Black





COMMANDER



XTREME FRONT BUMPER

- Delivers additional heavy-duty protection that works with or without the Front XT Bumper (715000958).
- Anti-corrosion coating with durable powder coat finish.
- Can-Am logo tag.
- Not available on EC homologated vehicles.

Fits: RU
715000951



XT FRONT BUMPER

- Made of heavy gauge steel for additional protection.
- XT styled for matching appearance.
- Anti-corrosion coating with durable powder coat finish.
- Effortless mounting.
- Standard on XT, XT-P and Limited models.

Fits: RU
715000958

COMMANDER



FRONT LIGHT PROTECTION

- Works in conjunction with Front XT Bumper (715000958), offering protection to front headlights and sporting aggressive look.
- Anti-corrosion coating with durable powder coat finish.
- Integrated Can-Am fastening system provides efficient mounting vs traditional P-clamps.

Fits: RU
715000656



FRONT ACCESSORY BAR

- Can-Am casted clamps for easy mounting.
- Anti-corrosion coating with durable powder coat finish.
- Allows installation of Front Rack (715000985) and HID or Halogen lights and LED bars (sold separately).
- Not compatible with XT Front Bumper (715000958).

Fits: RU (except Limited, XT, XT-P and Mossy Oak Hunting Edition models)
715001377 • Black



FRONT RACK

- Equipped with genuine Can-Am clamps for easy mounting on required XT Front Bumper (715000958) or Front Accessory Bar (715001377) (sold separately).
- Anti-corrosion coating with durable powder coat finish.
- Allows access to air filter, washer fluid or coolant.
- 75 lbs (34 kg) load capacity.

Fits: RU
715000985



XT BOX RAILS

- Add integrated tie down area to your cargo box while enhancing the look.
- Anti-corrosion coating with durable powder coat finish.
- Standard on XT and Limited models.

Fits: RU
715000957

REAR BUMPER

- Integrated tubular system provides sporty look while protecting vehicle's bodywork.
- Flips with cargo box and lower tailgate.

Fits: RU
715000657

LOWER TAILGATE PROTECTOR

- Aluminum body plating covering lower tailgate provides additional protection and aggressive look.

Fits: RU
715001097





DEFENDER



MUST HAVE



NEW

TONNEAU COVER

- Fitted to cover all of the items in your cargo box thoroughly.
- Prevents splash from entering the cargo box.
- Rolls up to the front.
- Easily removable for quick access.
- Not compatible with accessories that exceed the box height.

Fits: UR (except Mossy Oak Hunting Edition models)

715003017 - Black 715003048 - Mossy Oak Break-Up Country Camo

CATCH THE VIDEO AT CAN-AMOFFROAD.COM



HEADACHE RACK

- Protects cab components from cargo load.
- Increases box capacity when used in tandem with the Bed Wall Extender (715002421).
- Required to install the Bed Wall Extender (715002421) and Gear Rail (715003391).

Fits: UR
715002423

DEFENDER

LinQ SYSTEM

NEW

LinQ TAILGATE EXTENSION/DIVIDER

- Adds rear cargo capacity when the tailgate is open.
- Steel-tubing-system-style barrier mounts on top of the bed walls using the easy, tool-less LinQ System.
- Can be mounted to serve as cargo divider at different locations along the bed wall while preventing larger items from falling off the back.
- Stores neatly out of the way and offers additional cab area protection since it can be mounted upside down on the front bed wall as a mini headache rack.
- Inside and outside anti-corrosion coating with durable powder coat finish.

Fits: UR
715002464



BED WALL EXTENDER

- Increases box capacity.
- Quick and easy tool-less modularity.
- Easily-removable rear door can be latched open.
- Variable full or half height settings.
- Foldable top panels come off in seconds.
- Requires Headache Rack (715002423).

Fits: UR
715002421

LinQ SYSTEM

LinQ TOOL HOLDER

- Ultra-versatile tool holder.
- Convenient swivel-latch allows tools to be stored in any orientation.
- Suitable for installation onto the cargo walls, Headache Rack (715002423), or Bed Wall Extender (715002421).
- If mounted on the Headache Rack (715002423) or the Bed Wall Extender (715002421), LinQ Adaptor (715003058) is required for installation.
- Sold in pairs.

Fits: UR
715003059



LinQ SYSTEM

LinQ ADAPTOR

- (Not illustrated)
- Allows the installation of the LinQ Tool Holder (715003059) to the Bed Wall Extender (715002421) or the Headache Rack (715002423).
- Sold in pack of 4.

Fits: UR, SSP
715003058

Some products shown may not be available or homologated in your country. Contact your BRP dealer for local details.



DEFENDER



CATCH THE VIDEO AT [CAN-AMOFFROAD.COM](https://can-amoffroad.com)



MUST HAVE

LinQ
SYSTEM™

NEW

LinQ LOW PROFILE BASKET

- Low profile, open basket increases cargo space.
- Perfect for easy access to tools, rope, winch and plow accessories.
- Multiple bungee cord and tie-down anchor points.
- Made of impact-resistant injected polypropylene.
- LinQ Cargo Rack (715003443) or LinQ Front Rack (715002420) is required for installation on UR.

Fits: UR
715003027



LinQ
SYSTEM™

NEW

LinQ FRONT RACK

- Rugged looking front rack mounts on top of vehicle hood and provides additional storage.
- Heavy-duty 1.25" (3 cm) diameter steel-tube construction.
- Inside and outside anti-corrosion coating with durable powder coat finish.
- Flip-up configuration provides easy access to service area.
- Allows the installation of LinQ accessories (especially for use with LinQ Low Profile Basket (715003027)).
- Kit includes LinQ Base.
- Multiple bungee cord and tie-down anchor points.
- Requires Rancher Bumper (715002834) or Front Bumper (715002418) for installation.
- A great place to store tools while working in the field.
- Not compatible with flip windshields.

Fits: UR
715002420



DEFENDER



LinQ
SYSTEM™

NEW

LinQ CARGO RACK

- Strong, durable steel rack.
- Easy and tool-less installation thanks to the LinQ System.
- Allows the installation of LinQ accessories.
- 2 racks can be installed at the same time.
- Allows multi-level storage on cargo bed (accommodates 5 Gal (19L) bucket).

Fits: UR
715003443

- Helps keep cargo securely in place.
- Multiple bungee cord and tie-down anchor points.
- Kit includes LinQ Base.
- Provides more usable space in the cargo box.
- Extends vehicle cargo options.



LinQ
SYSTEM™

NEW

LinQ TIRE HOLDER

- Cargo box spare-tire holder.
- Inside and outside anti-corrosion coating with durable powder coat finish.
- Heavy-duty steel construction.
- Mounts on top of the bed walls using the easy, tool-less LinQ System.
- Uses BRP standard wheel bolt pattern to mount tire (nuts included).

Fits: UR (except Mossy Oak Hunting Edition models)
715003448

- Accommodates BRP tires up to 28" (tire not included).
- Allows installation in multiple position quickly thanks to the LinQ System.
- Compatible with Bed Wall Extender.



DEFENDER



NEW

DRIVER UNDERSEAT STORAGE BIN

- Polypropylene-injected 4 Gal (15L) capacity bin fits securely under the driver's seat.
- Front opening for quick and easy access.
- Ideal for storing weather-resistant items, such as ropes, tow straps and winch accessories that are needed at a moment's notice.

Fits: UR
715003399



NEW

CENTER UNDERSEAT STORAGE BIN

- Polypropylene-injected 2 Gal (8L) capacity storage bin.
- Watertight design keep ice and drinks cold.
- Easy to drain and wash by removing it with integrated handle.
- Accessible by lifting center seat section.

Fits: UR
715003446

MUST HAVE



NEW

REMOVABLE STORAGE BIN - PASSENGER

- Convenient passenger-side under-seat storage polypropylene-injected 3.7 Gal (14L) storage capacity bin.
- Bin installs and removes in a snap and comes with an integrated handle.
- Water-resistant.

Fits: UR
715003314

DEFENDER



NEW

CARGO BED RAILS

- Add integrated tie down area to your cargo box while enhancing the look.
- Added cargo box protection.
- Inside and outside anti-corrosion coating with durable powder coat finish.
- Heavy-duty 1" (2.5 cm) diameter steel-tube construction.
- Add height to the bed sidewall and serve as a tie-down anchor for ropes, straps or bungees.
- Not compatible with Bedwall Extender (715002421).
- Sold in pairs.

Fits: UR
715003444



NEW

CARGO BED NET

- Solid net designed to hook to the bottom of the cargo box for secure and compact confinement of your cargo.
- Keeps items tightly against the bed floor.

Fits: UR
715003445

NEW

DASH STORAGE COMPARTMENT NETS

- Perfect for securing items in the dash storage area.
- Not compatible with Defrost, Heat & Ventilation System (715001978).
- Sold in pairs.

Fits: UR (except XT Cab models)
715003129



NEW

DASH STORAGE COMPARTMENT NET FOR HEATING SYSTEM

- Perfect for securing items in the dash storage area.
- To be installed when Defrost, Heat & Ventilation System (715001978) is in place.

Fits: UR
715003544



NEW

BACKREST REAR STORAGE

- Netting installs easily.
- Made from polyester that won't discolor.
- Sold in pairs.

Fits: UR (MAX models only)
715003019



NEW

LOWER DASHBOARD FOR HEATING SYSTEM

- Replaces the dashboard that comes stock with the vehicle, and features a tablet that makes it possible for driver and passenger to conveniently store small items in the dash.
- To be used when the Defrost, Heat & Ventilation System (715001978) is installed.
- Use together with the Dash Storage Compartment Net for Heating System (715003544) to prevent the items placed in the dash storage compartment from falling.

Fits: UR
715003441





DEFENDER



NEW

GEAR RAIL ADAPTOR

- Allows the installation of the Gear Rail (715003391) directly onto the cargo box without the need for the headache rack.

Fits: UR
715003392



NEW

DUAL GUN HOLDER

- Accommodates shotguns, rifles or muzzleloaders.
- Mounts in the cab, on floor board between driver and passenger.
- Rubber pads provide gun protection.
- Easily removed to allow for a center passenger.
- Anti-corrosion coating with durable powder coat finish.
- Comes with all hardware for easy installation.
- Keeps your weapons within easy reach and protected within the cab area.
- Refer to your local regulations governing the transportation of firearms before purchase.

Fits: UR
715003447

DEFENDER MAVERICK COMMANDER

Snap-close cover with locking capability



GUN BOOT 6.0 IMPACT⁺ BY KOLPIN⁺

- Extra room for pistol-grip-type weapons and small bipods.
- Easily fits firearms up to 51" (1.3 m) in total length.
- Provides ample room for 2.4" (60 mm) scopes.
- Hatchback design allows easy access.
- Snap-close cover with locking capability.

715001419 • Black

- Ergonomically designed handle and molded attachment points for sling.
- Designed to accommodate left and right hand bolt-action rifles and shotguns.

- Requires Gear Rail (715001420) and Gun Boot Mount by Kolpin (715001320 or 715003391) for installation.
- Includes removable, shock absorbing foam and nylon Impact liner for superior interior protection.
- Compatible for dual mount with Additional Gun Boot Mount (715001586).



GUN BOOT MOUNT BY KOLPIN

- Fits one Kolpin Gun Boot 6.0 Impact (715001419).
- Lightweight and extremely durable.
- Easily adjustable without the use of any tools.
- Offers precision gun angle adjustability.
- Requires Gear Rail (715001320 or 715003391) for installation.

Fits: RS (except Turbo, X ds Turbo, X rs Turbo 2016 & up models), UR, RU
715001420 • Black



ADDITIONAL GUN BOOT MOUNT
(Not illustrated)

Fits: RS (except Turbo, X ds Turbo, X rs Turbo 2016 & up models), UR, RU
715001586



DEFENDER MAVERICK COMMANDER

GEAR RAIL

- Stationary rail system specially designed for your Side-by-side vehicle.
- Mounts on roll bar.
- Universal mounting options for many Kolpin accessories like Gear Grips, Gun Boot 6.0, Gun Boot Mount and Universal Saw Press.
- Rail is made with heavy-duty 7-gauge extruded anodized black aluminum.
- Includes one versatile Gear Rail Mount by Kolpin (715001422).

Fits: RS (except Turbo, X ds Turbo, X rs Turbo 2016 & up models), RU 715001320 - Black

Fits: UR
 • Requires Headache Rack (715002423 or 715003392).
 715003391



Includes one versatile Gear Rail Mount by Kolpin (715001422)

DEFENDER MAVERICK COMMANDER



GEAR RAIL MOUNT BY KOLPIN

- Accessory bracket for mounting additional accessories to the Gear Rail.
- Includes C-clamp and metal mounting brackets.

Fits: RS (except Turbo, X ds Turbo, X rs Turbo 2016 & up models), UR, RU 715001422



UNIVERSAL SAW PRESS BY KOLPIN

- Specially crafted for transporting your chainsaw securely and safely aboard your Side-by-side vehicle.
- Heavy-duty, black powder-coated metal bracket designed to attach any chainsaw model with up to a 20" (51 cm) bar.
- Rubber pads provide cushion and tight fit.
- Hinged design for quick removal.
- Holds saw in vertical position or 45° angle in either direction.
- Requires Gear Rail (715001320 or 715003391).
- Protective sheath included.

Fits: RS (except Turbo, X ds Turbo, X rs Turbo 2016 & up models), UR, RU 715001423 - Black



GEAR GRIPS BY KOLPIN

- Durable, flexible grips cushion and protect while providing a custom fit for a variety of items from 1" to 4" (2.5 cm to 10 cm) in diameter.
- Heavy-duty design for carrying bows, fishing poles, rakes, farm tools and more.
- Quick-release button opens grip quickly for easy access to gear.
- Heavy-duty base system built for the toughest adventures.
- Easy installation on tubular racks, extension racks, brackets or bumpers.
- Sold in pairs.

Fits: RS (except Turbo, X ds Turbo, X rs Turbo 2016 & up models), UR (except Mossy Oak models), RU 715001421



LinQ MOUNTED GEAR GRIPS BY KOLPIN

- (Not illustrated)
- Same features as Gear Grip by Kolpin (715001421).
 - Make transporting your tools a snap by combining the Gear Grips with the LinQ System.
 - 360° orientation.

Fits: RS (except Turbo, X ds Turbo, X rs Turbo 2016 & up models), RU 715001351



FUEL PACK BRACKET BY KOLPIN

- Easy, quick and secure bracket for your fuel pack that leaves plenty of room for your other gear.
- ¼-turn-action knob allows quick and easy removal of fuel pack from bracket.
- Not EC compliant to attach fuel packs.

Fits: RS (except Turbo, X ds Turbo, X rs Turbo 2016 & up models), UR (except Mossy Oak models), RU 715001427 - Black



MAVERICK COMMANDER

GEAR RAIL ADAPTOR FOR REAR WINDOW

- Allows you to install a Gear Rail on a rear window.

Fits: RS (except Turbo, X ds Turbo, X rs Turbo 2016 & up models), RU 2014 & up 715002545





COMMANDER

TONNEAU COVER

- Thoroughly covers and secures your cargo box items.
- Prevents splash from entering the cargo box.
- Easily removable for quick access.
- Fits with or without XT Box Rails (715000957).

Fits: RU

715001194 • Black



MAVERICK

CARGO BED LINER

- Covers the rear end of your vehicle.
- Includes solid mounting location to attach your stuff.
- Tool-less removal.
- Made of durable polyethylene plastic.

Fits: RS (except Turbo, X ds Turbo, X rs Turbo 2016 & up)

715001904 • Black



DEFENDER MAVERICK COMMANDER

LinQ
SYSTEM™

LinQ DELUXE MODULAR BAGS

- Tool-less installation and removal.
- Versatile, rugged and spacious.
- Ideal for carrying anything you need in any conditions.
- Weatherproof, scratch-resistant, with molded rubber bottom.
- Central compartment can be used alone on the rack.
- Removable bin.

Fits: RS (except Turbo, X ds Turbo, X rs Turbo 2016 & up models), SSP

715001695 • 12 Gal (44L)

715001694 • 20 Gal (73L)



Removable Bin

CARGO BAG

- Rugged all-purpose cargo bag with rain cover for additional protection against the elements.

Fits: RS, RU, UR

280000539 • Black



Rain cover for additional protection



REAR ARMREST COOLER BOX

- Designed specifically for insertion in the compartment nestled between the 2 rear seats of a Commander MAX or Maverick MAX.
- Magnetic lid makes removal a breeze.
- Can hold 6 cans (5L).

Fits: RS (except Turbo, X ds Turbo, X rs Turbo 2016 & up models), RU

715001961



BACKREST REAR STORAGE

- Netting installs and unfastens easily.
- Made from polyester that won't discolor.
- Sold in pairs.

Fits: RS, RU (MAX models only)

715001960



CARGO BOX NET

- Solid net designed to hook to the bottom of the cargo box for secure and compact confinement of your cargo.

Fits: RU

715001371 • Black



SOFT STORAGE BAG

(Not illustrated)

- 3-section bag.
- Transport gear in a weatherproof bag.
- 6" (15 cm) tall soft cargo bag designed with vehicle's rear rack and rack extensions in mind to maximize potential storage.

Fits: RS (except Turbo, X ds Turbo, X rs Turbo 2016 & up models)

715001934

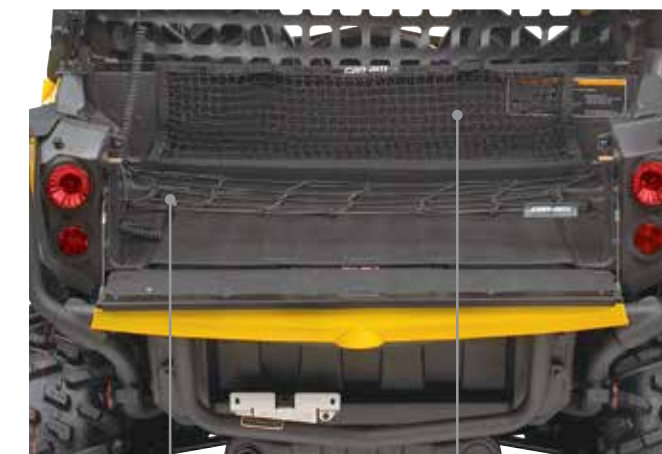

CARGO BOX ELASTIC NET

- Elastic net designed to hook to the bottom of the cargo box.
- Ideal for retaining lighter, irregular-shaped items.

Fits: RU

715001372 • Black

CARGO BOX STORAGE NET

- Mesh net.
- Stores items vertically.
- Quick installation.

Fits: RU

715001370 • Black



MAVERICK



LinQ 32 GAL (124L) TRUNK BOX

- Equipped with the LinQ System, the rear trunk box plugs in and out in seconds.
- 32 Gal (124L) load capacity with unobstructed space to maximize storage room and access to the trunk's interior.
- Made of injection-molded polyethylene, double walled in critical areas.
- The fully sealed lid protects your belongings from dust, moisture and the elements.

Fits: RS, SSP

- 715001747 - Rear tail light included
- 715001748 - No rear tail light (EC Model)

- Requires Wiring Cable (710003419).
- Rear tail light.
- Trunk Box Panels available in many colors to match your vehicle (sold separately).
- Not compatible with Lonestar Racing Rear Intrusion Bar and Baja-Style Spare Tire Holder.

WIRING CABLE FOR LinQ TRUNK BOX

- Required for the tail light to function.

Fits: RS

710003419 - Black



LinQ 32 GAL (124L) TRUNK BOX PANELS

- Fit LinQ 32 Gal (124L) Trunk Box (715001747).
- Color pannels to match the LinQ 32 Gal (124L) to your vehicle.

Fits: LinQ 32 Gal (124L) Trunk Box

- 715001391 - Black
- 715001392 - Yellow
- 715001395 - Viper Red
- 715002481 - White
- 715002480 - Light Grey
- 715002984 - Octane Blue
- 715002985 - Manta Green
- 715002986 - Can-Am Red

EUROPEAN VERSION (EC compliant)

- No rear tail light
- 715001397 - Black
- 715001398 - Yellow
- 715002482 - Light Grey
- 715002483 - White



LinQ 20 GAL (74L) TRUNK BOX

- Installs without vehicle modification.
- LinQ mount for easy-on, easy-off installation.
- Lockable and weather-resistant.
- Holds cargo safely and securely while riding.
- Not compatible with Lonestar Racing Rear Intrusion Bar and Baja-Style Spare Tire Holder.

Fits: RS (except Turbo, X ds Turbo, X rs Turbo 2016 & up), SSP
715002473



DEFENDER MAVERICK

CATCH THE VIDEO AT CAN-AMOFFROAD.COM



NEW

LinQ 11.5 GAL (43L) AUDIO CARGO BOX

- An affordable and quick solution for adding music and storage to your next ride. The rear installation does not use up any cab space and allows easy listening at an average speed.
- Mounts on/off easily to hold/carry cargo safely and securely.
- The Bluetooth enabled receiver and 6.5" (16.5 cm) speakers are smartly concealed and integrated in the cover.
- Automatic shut-off function protects your battery by turning the system off after 10 minutes of inactivity.
- Backlit control panel perfect for night riding.
- LinQ Cargo Rack (715003443) is required for Defender.
- Not compatible with Lonestar Racing Rear Intrusion Bar.

Fits: UR, RS (except Turbo, X ds Turbo, X rs Turbo 2016 & up), SSP
715003018



MUST HAVE



LinQ 12 GAL (45L) CARGO BOX

- Holds cargo safely and securely while riding.
- Easy and fast to install and remove from racks thanks to the LinQ System.
- Flip-over cover becomes a tray.

Fits: UR, RS (except Turbo, X ds Turbo, X rs Turbo 2016 & up), SSP
715001936



LinQ 23 GAL (86L) TRUNK BOX

- Installs without vehicle modification.
- LinQ mounted for easy-on, easy-off installation.
- Lockable and weather-resistant.
- Holds cargo safely and securely while riding.

Fits: RS, SSP
715002474



LinQ RACK EXTENSION

- Strong and durable.
- Helps keep cargo securely in place.
- Easy and tool-less installation thanks to the LinQ System.
- Inside and outside anti-corrosion coating with durable powder coat finish.

Fits: RS

- 715001665 - Black 4" (10 cm)
- 715001711 - Silver 4" (10 cm)

- 715001671 - Black 6" (15 cm)
- 715001712 - Silver 6" (15 cm)

TO BUILD YOUR LIGHTING SYSTEM, REFER TO PAGES 150-151

MAVERICK COMMANDER

CATCH THE VIDEO AT CAN-AMOFFROAD.COM

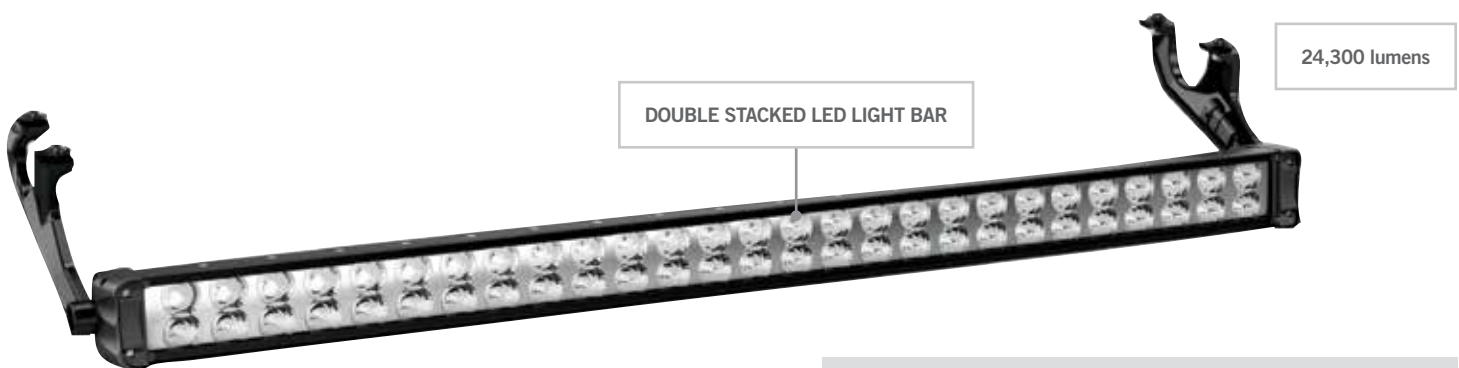

39" (99 CM) DOUBLE STACKED LED LIGHT BAR (270 WATTS)

- Equipped with 54 5W Cree LEDs.
- 24,300 lumens.
- Sits protected inside the cage area to deliver powerful and accurate lighting.
- Includes installation brackets and wiring harness.
- Not compatible with Full Windshield, Flip Windshield and Intrusion Bar.

Fits: **RS, RU**
715002932

LIGHTS UP TO MORE THAN 2900 FT (900 M) IN FRONT OF THE VEHICLE AND AROUND 115 FT (35 M) WIDE ON EACH SIDE

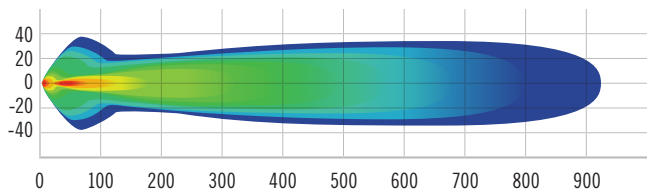

DEFENDER MAVERICK COMMANDER



15" (38 CM) DOUBLE STACKED LED LIGHT BAR (90 WATTS)

- Equipped with 18 5W Cree LEDs.
- 8,400 lumens.
- Complements the Light Rack for Sport Visor and most bumpers.
- Includes wiring kit and switch.

Fits: **UR, RS, RU, SSP**
715002934

LIGHTS UP TO MORE THAN 1900 FT (580 M) IN FRONT OF THE VEHICLE AND AROUND 65 FT (20 M) WIDE ON EACH SIDE

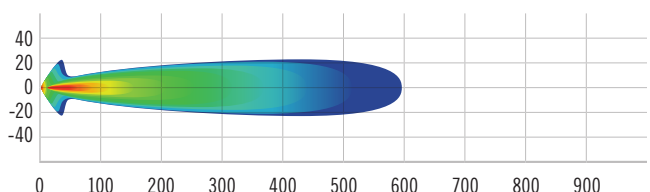

10" (25 CM) DOUBLE STACKED LED LIGHT BAR (60 WATTS)

- Equipped with 12 5W Cree LEDs.
- 5,400 lumens.
- Packs a big punch for its size.
- Includes wiring kit and switch.
- Not compatible with Front Pre-Runner Bumper (715001645).

Fits: **UR, RS, RU, SSP**
715002933

LIGHTS UP TO MORE THAN 1500 FT (460 M) IN FRONT OF THE VEHICLE AND AROUND 65 FT (20 M) WIDE ON EACH SIDE

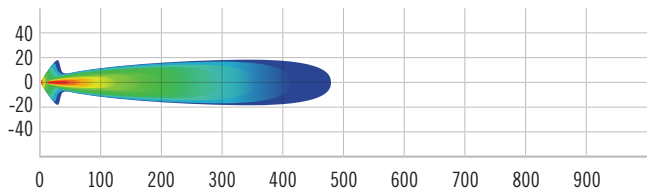

*All lights are intended for Off-Road use ONLY.

TO BUILD YOUR LIGHTING SYSTEM, REFER TO PAGES 150-151

DEFENDER



LIGHT RACK

- Rugged steel construction serves as both mount and protection for accessory light systems.
- Lights not included.
- Roof front liner is required for installation on the roof (except Cab models or with Deluxe Sport Roof (715002511)).
- Roof Power Cable (715003094), Sport Roof (715002430), Bimini Roof with Sun Visor (715002849), Deluxe Sport Roof (715002511) or Sport Roof for MAX (715003038) required for installation (except Cab models).
- Integrates elegantly and seamlessly into our roof products.

Fits: UR
715002456



REAR CARGO LIGHT

- Powerful 55W H3 illumination for rear cargo area.
- Convenient in-dash switch.
- Wiring included.
- Sport Roof (715002430), Deluxe Sport Roof (715002511) or Sport Roof for MAX (715003038) are required for installation.
- Not EC compliant.

Fits: UR
715002422

LIGHT KIT POWER CABLE

- (Not illustrated)
- Power cable for installation of compatible Can-Am light kits on Front Bumper (715002418) or Rancher Bumper (715002834).

Fits: UR
715002454

ROOF POWER CABLE

- (Not illustrated)
- Fully integrated with the vehicle.
 - Required to install lights on the roof.

Fits: UR
715003094

DEFENDER MAVERICK COMMANDER



2 x 1,800 lumens

4" (10 CM) ROUND LED LIGHTS (2 X 25 WATTS)

- 25W LED spotlights.
- 2 x 1,800 lumens.
- Rugged and waterproof.
- Includes basic wiring and switch.
- Can-Am branded grill.
- Perfect fit with the Light Rack for Sport Visor and most bumpers with Light Mount Kit.
- Sold in pairs.
- Not EC compliant.

Fits: UR, RS, RU, SSP
715002935



NEW

RAM[†] LED SPOTLIGHT

- 540 lumens LED light (9 Watt) heavy-duty spotlight standard-equipped with 1" (2.5 cm) diameter rubber-coated double ball and socket system.

Fits: UR, RU 2012 & up
710005423 • Black

DEFENDER MAVERICK COMMANDER



Luminous flux is 2.5 times higher than a conventional halogen bulb with 35% less energy consumption.

HID LIGHTS BY HELLA[†]

- Incomparable and powerful HID long range illumination plug-and-play system converts night usage into virtually daytime riding.
- Integrated ballast unit with 3.25" (8 cm) clear glass lens and swivel mounting heavy-duty bracket provides compact design.
- IP67 and IP6K9K rated water and dust proof.
- Highest electromagnetic compatibility rating, i.e. EMC Class 5 according to CISPR 25, for total disturbance-free electronic operation.
- Peak light performance with just 35W.
- Luminous flux is 2.5 times higher than conventional halogen bulb with 35% less energy consumption.
- High vibration resistance with longer lifetime than halogen bulb.
- Constant light intensity even under unsteady power supply voltage.
- Include basic wiring and switch.
- Sold in pack of 2.
- Not EC compliant.

Fits: UR (except bumper position), RS, RU, SSP
715001382



HALOGEN LIGHTS BY HELLA

- Deliver long range illumination.
- 3.25" (8 cm) clear glass lens and swivel mounting heavy-duty bracket provides compact design.
- Include basic wiring and switch.
- Sold in pack of 2.
- Not EC compliant.

Fits: UR, RS, RU, SSP
715001383

DOME LIGHT

- LED array integrates perfectly with vehicle.
- Wiring included.
- Can be installed on cage or roof, with or without roof liner.

Fits: UR, RS, RU, SSP
715002455



MAVERICK COMMANDER

LIGHT RACK FOR SPORT VISOR

- Provides Can-Am Side-by-side vehicles with a custom look.
- Made of rugged aluminum.
- Essential protection for your accessory lighting systems.
- Fully integrated.
- Can be mounted directly on the Sport Visor (715000762, 715001952 or 715002502).
- Wiring included.
- Lights sold separately.

Fits: RS, RU (except Limited models)
715001687 • Black
715001718 • Silver



LIGHT RACK FOR CAGE OR FOR ROOFS

- Provides Can-Am Side-by-side vehicle with a custom look.
- Made of rugged aluminum.
- Essential protection for your accessory lighting systems.
- Fully integrated.
- Can be fixed directly to the cage and can be used with Mesh Roof (715003130) or Sport Roof (715003395).
- Wiring included.
- Lights sold separately.

Fits: RS, RU (except Limited models)
715001094 • Silver
715001686 • Black



LIGHT MOUNTING KIT

- (Not illustrated)
- Required for installation of HID lights, Halogen lights or 4" round LED lights.
 - Switch not included.

Fits: RS 2016 & up (X ds 2015 & up), RU (except MAX models)
715001366 • Black

Fits: RS 2015 & prior (except X ds & MAX models), RU (MAX models only)
715001713 • Black

LIGHT POWER CABLE

- (Not illustrated)
- Brings power from rear battery to dash location.
 - Includes fuse for safety.

Fits: RS 2015 & prior (except X ds & MAX models), RU (MAX models only)
715002036

CATCH THE VIDEO AT CAN-AMOFFROAD.COM



2 x 900 lumens

FRONT BUMPER LIGHTS

- 2 x 900 lumens 10W LED Cree light kit.
- Long-range illumination up to 350' (107 m), drawing less than 1 amp per light.
- Include multi-position clamps that fit on various tubing sizes.
- Not EC compliant.

Fits: RS, RU with XT Front Bumper or Front Accessory Bar
715001741

LIGHT MOUNTING KIT FOR LED LIGHT BAR

- (Not illustrated)
- Required for installation of 10" (25 cm), 15" (38 cm) and 17" (43 cm) LED Light Bars on Bumpers or Front Accessory Bar.

Fits: RS, RU
715002175

*All lights are intended for Off-Road use ONLY.

BUILD YOUR LIGHTING SYSTEM - 4 STEPS TO A HASSLE-FREE ORDER

01 FIND YOUR PLATFORM	02 CHOOSE YOUR MOUNT POINT	03 CHOOSE YOUR LIGHTS		
		10" (25 CM) LED BAR	15" (38 CM) OR 17"(43 cm) LED BAR	39" (99 CM) LED BAR (2014 MODELS & UP)
UR	ORIGINAL BUMPER	NA	NA	NA
	FRONT BUMPER OR RANCHER BUMPER	715002933 (Double) PLUS 715002454 (Light Mount Kit)	715002934 (Double) PLUS 715002454 (Light Mount Kit)	NA
UR (EXCEPT XT CAB)	SPORT ROOF, DELUXE SPORT ROOF OR BIMINI ROOF <small>*Front Roof Liner (715003098) is required (except for Deluxe Sport Roof (715002511))</small>	715002933 (Double) PLUS 715002456 (Rack) & 715003094 (Roof Power Cable)	715002933 (Double) PLUS 715002456 (Rack) & 715003094 (Roof Power Cable)	NA
	ROOF WITH A DELUXE XT RIGID CAB ENCLOSURE <small>*Front Roof Liner (715003098) is required (except for Deluxe Sport Roof (715002511))</small>	715002933 (Double) PLUS 715002456 (Rack)	715002933 (Double) PLUS 715002456 (Rack)	NA
	ROOF OF THE PREMIUM RIGID CAB ENCLOSURE	715002933 (Double) PLUS 715002456 (Rack)	715002933 (Double) PLUS 715002456 (Rack)	NA
UR (XT CAB ONLY)	DELUXE SPORT ROOF	715002933 (Double) PLUS 715002456 (Rack)	715002933 (Double) PLUS 715002456 (Rack)	NA
RS <small>*For Maverick MAX and Maverick 2015 and prior (except X ds), Light Power Cable (715002036) is required.</small>	ORIGINAL BUMPER	715002933 (Double LED bar) PLUS 715002175 (Light Mounting Kit)	715002934 (15" Double LED bar) PLUS 715002175 (Light Mounting Kit)	NA
	PRE-RUNNER BUMPER	NA	715002934 (15" Double LED bar) PLUS 715002175 (Light Mounting Kit)	NA
	DUNE FRONT BUMPER	715002933 (Double LED bar) PLUS 715002175 (Light Mounting Kit)	715002934 (15" Double LED bar) PLUS 715002175 (Light Mounting Kit)	NA
	SPORT VISOR	715002933 (Double LED bar) PLUS 715001718 (Silver Rack) OR 715001687 (Black Rack)	715002934 (15" Double LED bar) PLUS 715001718 (Silver Rack) OR 715001687 (Black Rack)	715002932 (Double LED bar)
		715001094 (Silver Rack) OR 715001686 (Black Rack)	715001094 (Silver Rack) OR 715001686 (Black Rack)	
	SPORT ROOF, BIMINI ROOF OR ROLL CAGE	715002933 (Double LED bar) PLUS 715001094 (Silver Rack) OR 715001686 (Black Rack)	715002934 (15" Double LED bar) PLUS 715001094 (Silver Rack) OR 715001686 (Black Rack)	715002932 (Double LED bar)
SPORT ALUMINUM ROOF	NA	NA		
RU <small>*For Commander MAX, Light Power Cable (715002036) is required.</small>	FRONT XT BUMPER FRONT ACCESSORY BAR	715002933 (Double LED bar) PLUS 715002175 (Light Mounting Kit)	715002934 (15" Double LED bar) PLUS 715002175 (Light Mounting Kit)	NA
	SPORT VISOR	715002933 (Double LED bar) PLUS 715001718 (Silver Rack) OR 715001687 (Black Rack)	715002934 (15" Double LED bar) PLUS 715001718 (Silver Rack) OR 715001687 (Black Rack)	715002932 (Double LED bar)
		715001094 (Silver Rack) OR 715001686 (Black Rack)	715001094 (Silver Rack) OR 715001686 (Black Rack)	
	SPORT ROOF, BIMINI ROOF OR ROLL CAGE	715002933 (Double LED bar) PLUS 715001094 (Silver Rack) OR 715001686 (Black Rack)	715002934 (15" Double LED bar) PLUS 715001094 (Silver Rack) OR 715001686 (Black Rack)	715002932 (Double LED bar)
SPORT ALUMINUM ROOF	NA	NA		

All lights are intended for Off-Road use ONLY.

03 CHOOSE YOUR LIGHTS	04 ORDER	
		HID (SOLD IN PAIRS)
NA	NA	
NA	715001383 (Halogen) or 715002935 (LED) PLUS 715002454 (Light Mount Kit)	
715001382 (HID), 715001383 (Halogen) or 715002935 (LED) PLUS 715002456 (Rack) & 715003094 (Roof Power Cable)		
715001382 (HID), 715001383 (Halogen) or 715002935 (LED) PLUS 715002456 (Rack)		
715001382 (HID), 715001383 (Halogen) or 715002935 (LED) PLUS 715002456 (Rack)		
715001382 (HID), 715001383 (Halogen) or 715002935 (LED) PLUS 715002456 (Rack)		
715001382 (HID), 715001383 (Halogen) or 715002935 (LED) PLUS 715001366 or 715001713 (Light Mount Kit) when Light Power Cable (715002036) is required.		
715001382 (HID), 715001383 (Halogen) or 715002935 (LED) PLUS 715001366 or 715001713 (Light Mount Kit) when Light Power Cable (715002036) is required.		
715001382 (HID), 715001383 (Halogen) or 715002935 (LED) PLUS 715001366 or 715001713 (Light Mount Kit) when Light Power Cable (715002036) is required.		
715001382 (HID), 715001383 (Halogen) or 715002935 (LED) *SEE NOTE FOR 4-LIGHT INSTALL PLUS 715001718 (Silver Rack) OR 715001687 (Black Rack)		
715001382 (HID), 715001383 (Halogen) or 715002935 (LED) *SEE NOTE FOR 4-LIGHT INSTALL PLUS 715001094 (Silver Rack) OR 715001686 (Black Rack)		
NA		
715001382 (HID), 715001383 (Halogen) or 715002935 (LED) PLUS 715001366 for Commander or 715001713 for Commander MAX (Light Mount Kit)		
715001382 (HID), 715001383 (Halogen) or 715002935 (LED) *SEE NOTE FOR 4-LIGHT INSTALL PLUS 715001718 (Silver Rack) OR 715001687 (Black Rack)		
715001382 (HID), 715001383 (Halogen) or 715002935 (LED) *SEE NOTE FOR 4-LIGHT INSTALL PLUS 715001094 (Silver Rack) OR 715001686 (Black Rack)		
NA		

ORDER ALL PART NUMBERS IN THE INTERSECTING BOX
*NOTE: When installing more than one HID, Halogen or LED light kit on light rack, you only need to order one rack and one power cable.



DEFENDER



NEW

COMPLETE OVERHEAD AUDIO SYSTEM

- Rugged waterproof Jensen® Bluetooth Stereo Audio system offers multi-source input: AM/FM/WB and USB (iPod® and iPhone® ready).
- Convenient white LED-backlit LCD display and buttons.
- Stream from any Bluetooth-enabled device (smartphone, mp3 player).
- Powerful 4x40W amplifier with remote turn-on.
- Voice-control of AVRCP-active device.
- 30 programmable AM/FM stations with auto-store/pre-set scan.
- Separate RCA audio output and input.
- UV-resistant finish / corrosion-resistant components.
- Complete with 4 ultra-sturdy outdoor speakers (2 front and 2 rear) and 4 black speaker boxes.
- Requires Sport Roof (715002430 (except on XT and Mossy Oak Hunting Edition models)), Front Roof Liner (715003098) or Deluxe Sport Roof (715002511) and Roof Power Cable (715003094 (except if you already have a Hard Cab Enclosure (715001966 or 715003482))).

Fits: UR
715002019



NEW

OVERHEAD FRONT AUDIO SYSTEM

- Rugged waterproof Jensen® Bluetooth Stereo Audio system offers multi-source input: AM/FM/WB and USB (iPod® and iPhone® ready).
- Convenient white LED-backlit LCD display and buttons.
- Stream from any Bluetooth-enabled device (smartphone, mp3 player).
- Powerful 4x40W amplifier with remote turn-on.
- Voice-control of AVRCP-active device.
- 30 programmable AM/FM stations with auto-store/pre-set scan.
- Separate RCA audio output and input.
- UV-resistant finish / corrosion-resistant components.
- Complete with 2 ultra-sturdy front outdoor speakers and black speaker box.
- Requires Sport Roof (715002430 (except on XT and Mossy Oak Hunting Edition models)), Front Roof Liner (715003098) or Deluxe Sport Roof (715002511) and Roof Power Cable (715003094 (except if you already have a Hard Cab Enclosure (715001966 or 715003482))).

Fits: UR
715003095

RAM GPS MOUNT

- Allows for GPS integration onto vehicle.
- Standard AMPS hole pattern for Garmin Cradle.

Fits: UR
715003325



3-MODE SWITCH

- Switches quickly and conveniently between normal/work/eco modes.
- Work mode: Reduced throttle sensitivity for smoother acceleration and reduced load impact.
- Eco mode: Increased fuel economy.
- In-dash plug-and-play mount.
- Standard on XT, XT Cab and Mossy Oak Hunting Edition models.

Fits: UR
710004532



DEFENDER

POWER TILT-BED

- Powerful cargo box tilter with dash integrated switch.

Fits: UR
715000829



DIGITALLY ENCODED SECURITY SYSTEM (D.E.S.S.™) KEYS

- Top-security anti-theft protection for your vehicle.
- Encrypted chip technology restricts access to your vehicle's electronic ignition system.
- One vehicle / One code.
- A vibration / shock-resistant ball-and-socket design that ensures a reliable connection.
- Comes with 3 programmable keys:
 - Work key: limits vehicle speed to 40 kph (25 mph) but does not limit engine torque.
 - Normal key: limits vehicle speed to 70 kph (44 mph) and 10% torque reduction.
 - Performance key: No restrictions.

Fits: UR
715002458



DEFENDER MAVERICK COMMANDER

NEW

GARMIN MONTANA® 680T GPS

- Rugged and waterproof, the Montana 680T is element-proof.
- 4-inch dual-orientation, sunlight-readable touchscreen and glove-friendly touchscreen display, to give you vivid colors and high-resolution images.
- 8-megapixel autofocus camera automatically geotags photos.
- Tracks both GPS and GLONASS satellites for improved positioning and typically faster fixes.
- Preloaded TOPO maps, plus 1-year BirdsEye Satellite Imagery subscription.
- 3-axis compass with barometric altimeter.
- Specific GPS cradle included (vehicle mounting kit required).
- Includes a preloaded map for US.
- RAM GPS Mount (715003325) required for UR.
- Radio/GPS Console Adapter (715001404) required on RS, RU (except X mr models and with Snorkel Kit (715001728)).

Fits: UR, RS, RU, SSP
715002830

EUROPEAN VERSION

- EC compliant.
 - Includes preloaded European recreation map.
- 715003456



NEW

CANADIAN MAP FOR GARMIN MONTANA 680T GPS

- (Not illustrated)
- Additional and readily-programmable Canadian basemap for Garmin Montana 680T GPS system.
- Requires Garmin Montana 680T GPS (715002830).

Fits: UR, RS, RU
710005065



MAVERICK COMMANDER

WET SOUNDS STEALTH 6 ULTRA CAN-AM EDITION SOUND BAR

- Built-in full range class D amplifier (200W RMS, 400W peak).
- Integrated Bluetooth enabled receiver.
- Aux input allows for use with non-Bluetooth devices.
- Automatic shut-off function protects your battery.
- Turns itself off after 10 minutes of inactivity.
- Backlit control panel.
- 2V line-output allows for hooking up another sound bar or adding an external amplifier and speakers.
- Not compatible with Light Rack.

Fits: RS, RU (except Limited models)

715002086

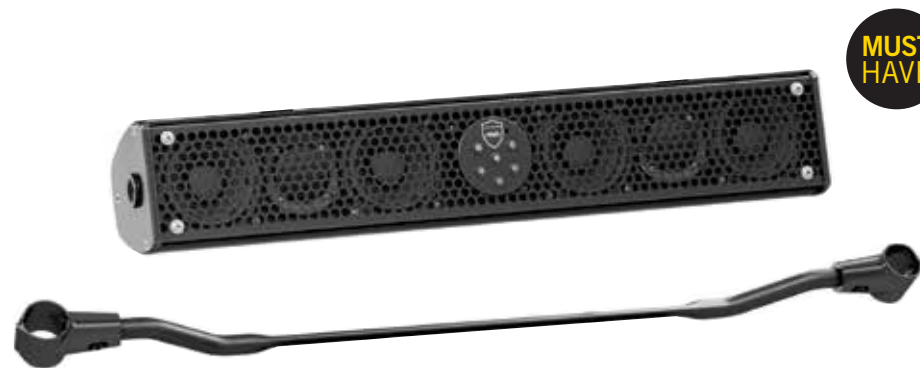

MUST HAVE

Some products shown may not be available or homologated in your country. Contact your BRP dealer for local details.



MAVERICK COMMANDER

CGX2 CAMERA

- 4K HD and 1080p at 60fps.
- 2" LCD display screen.
- Waterproof housing up to 165 ft (50 m) underwater and 2.4gh waterproof remote.
- Comes with 32GB Micro SD Card Class 10 and 9 mounts.
- WIFI available to control your camera from your smartphone or tablet with the free iCyclops App for IOS and Android.

2866860090



MUST HAVE

THERE'S MUCH MORE TO SEE – CHECK OUT THE CYCLOPS 360 ON PAGE 184



FRONT & REAR SPEAKERS

- Great sounding outdoor speakers.
- Kit includes black speaker boxes and plug-and-play wiring.
- Set of 2.
- Standard on Limited model.

Fits: RS, RU

715001309 • Front 5.25" (13 cm)

715001315 • Rear 6.5" (16.5 cm)

Included in the Complete Audio System

COMPLETE AUDIO SYSTEM

- This integrated Jensen wired remote, amplifier/receiver and speaker combination provides durability, convenience and ease of installation.
- The waterproof design and UV-resistant materials mean no matter how extreme your riding, this system will follow you throughout.
- LED illumination makes it easy to use and to read.
- You can select between AM/FM tuner, 7-channel weather band or listen to your favorites with your iPod (USB 2.0 and MP3/WMA compatible).
- Plug-and-play wiring.
- 50W x4, -10°C to 60°C operating range.
- Radio/GPS Console Adapter (715001404) required (except X mr models and except with Snorkel Kit (715001728)).
- Standard on Limited model.

Fits: RS, RU

715001197



RADIO / GPS CONSOLE ADAPTOR

- Update center console for GPS and/or audio system integration.
- Includes a cover for unused GPS or audio system slot.
- Standard on Limited model.

Fits: RS, RU

715001404 • Black



Glow-through whip, quickly removable

Includes adjustable mounting brackets

ADJUSTABLE LIGHTED WHIP FLAG

- A must for riding the dunes.
- 5W Cree LED.
- 5 colored lenses to allow personalization.
- Glow-through whip, quickly-removable and replaceable pole.
- Increases vehicle's visibility.
- Meets most dune-area requirements.
- Die cast aluminum base, acetal hand nut.
- Includes adjustable mounting brackets and wiring.

Fits: RS, RU

715001651



DEFENDER MAVERICK COMMANDER

DEFROST, HEAT & VENTILATION SYSTEM

- Best integrated system on the market with 3-ventilation speed and in-dash adjustable temperature.
- Adjustable/directional vents.

Fits: RS, RU (except X mr models)

- 6 vents specially positioned for better windshield defrosting/deicing, foot and hand heat.

715001390

Fits: UR

- 10 vents specially positioned for better windshield and side windows defrosting/deicing, foot and hand heat.
- Easy-service air filter.
- Once installed, you might want to add storage space with the Lower Dashboard for Heating System (715003441) and Dash Storage Compartment Net for Heating System (715003544).

NEW 715001978

MUST HAVE



HEATED VISOR OUTLET

- Strategically positioned on vehicle to maintain your agility.
- Optional visor outlet that delivers fog-free riding.
- Quick and easy installation.
- Sold individually.
- Heated Visor not included.

Fits: RS, RU, UR, SSP

715001246

Some products shown may not be available or homologated in your country. Contact your BRP dealer for local details.



DEFENDER MAVERICK COMMANDER

[CATCH THE VIDEO AT CAN-AMOFFROAD.COM](https://can-amoffroad.com)

WARN[†] PROVANTAGE

- Patented roller disc brake for enhanced winching control.
- Ergonomic clutch handle.
- Three-stage planetary gear train for smooth, efficient operation.
- All-metal gear housing and gears.
- Fully sealed motor and drive train keep the elements out.

- Weather sealed corded remote and dash mounted switch.
- Limited lifetime warranty for mechanical components and 3-year warranty for electrical components.
- EC compliant.



WARN PROVANTAGE 4500-S WINCH

- Pulling strength capability of 4,500 lb (2,041 kg).
- 50 ft. of 7/32" (15.2 m of 5.5 mm) synthetic rope.
- Double-powder-coated hawse fairlead.
- Winch Electrical Harness (715003093) is required for installation on UR base and DPS models.
- Winch Electrical Harness (710005215) is required for installation on RS 2017 & up (except X mr models).

Fits: UR, SSP

715002941

Fits: RS, RU

- Mounting Plate is required.
- A Pre-Runner is required for RS X ds, X rs 2016 & up.

715002501



WARN PROVANTAGE 4500 WINCH

- Pulling strength capability of 4,500 lb (2,041 kg).
- 55 ft. of 7/32" (16.8 m of 5.5 mm) wire steel cable.
- Roller fairlead.
- Winch Electrical Harness (715003093) is required for installation on UR base and DPS models.
- Winch Electrical Harness (710005215) is required for installation on RS 2017 & up (except X mr models).

Fits: UR, SSP

715002425

Fits: RS, RU

- Mounting Plate is required.
- A Pre-Runner is required for RS X ds, X rs 2016 & up.

715002560

CAN-AM TERRA BY SUPERWINCH[†]

- Ergonomic clutch handle.
- Rugged all-steel gears and bushings for more torque and durability.
- 100% mechanical load holding brake.

- Sealed solenoid for all-weather protection.
- Weather sealed corded remote and dash mounted switch.
- EC compliant.

CAN-AM TERRA 45 WINCH BY SUPERWINCH

- Pulling strength capability of 4,500 lb (2,041 kg).
- 47 ft. of 1/4" (14.3 m of 6.3 mm) wire steel cable.
- Heavy-duty 4-way roller fairlead.
- Winch Electrical Harness (715003093) is required for installation on UR base and DPS models (except XT models).
- Winch Electrical Harness (710005215) is required for installation on RS 2017 & up (except X mr models).

Fits: UR, SSP

715002838

Fits: RS, RU

- Mounting Plate is required.
- A Pre-Runner is required for RS X ds, X rs 2016 & up.

715002092





DEFENDER



REMOVABLE WINCH MOUNTING KIT

- Allows to remove your winch when needed.
- Use in combination with the Multimount Winch Harness (710004869) to quickly and conveniently relocate a front-mounted winch to the rear of the vehicle.
- Not compatible for use with the Lower Front Receiver Hitch.
- Requires Higher Front Receiver Hitch (715003109).

Fits: UR
715001652



LOWER FRONT RECEIVER HITCH

- Heavy-duty 1,500 lb (680 kg) towing capacity 2" (5 cm) receiver hitch.
- Expand and enhance functionality by pairing it with Higher Front Receiver Hitch (715003109) and Removable Winch Mounting Kit (715001652 (need to relocate winch from its standard mounting position)).

Fits: UR
715002519



HIGHER FRONT RECEIVER HITCH

- Heavy-duty 1,500 lb (680 kg) towing capacity 2" (5 cm) receiver hitch.
- No need to relocate winch from its standard mounting position.

Fits: UR
715003109



DROP TOW BAR

- Sturdy 2" (5 cm) ball-less tow bar.
- Conveniently set at standard trailering height.
- Requires Higher Front Receiver Hitch (715003109).

Fits: UR
715002521

WINCH ELECTRICAL HARNESS

- (Not illustrated)
- Required to install a winch on base and DPS models.

Fits: UR
715003093

MULTIMOUNT WINCH HARNESS

- (Not illustrated)
- Converts Removable Winch Mounting Kit (715001652) into a practical multimount winch kit.

Fits: UR (except MAX models)
710004869

Fits: UR (MAX models only)
NEW 710005082

NEW

WIRED REMOTE CONTROL

- This kit allows winch owners to add the hand-held remote to vehicles with a stock SuperWinch.
- Works in conjunction with the mini-rocker switch.

Fits: All model
710004887

- Warn Remote Socket (715003651) is required.
- OEM stock winch and Wired Remote Control are sold separately.
- EC compliant.



DEFENDER MAVERICK COMMANDER

FRONT & REAR HITCH DRAWBAR

- Fits 2" (5 cm) receiver hitch that comes standard on Defender and the Lower and Higher Front Receiver Hitches (715002519).
- Hitch ball not included.

Fits: UR, RS, RU
715000972



EUROPEAN VERSION

715001473 • Drawbar with 50 mm European ball

DEFENDER MAVERICK COMMANDER

MULTIMOUNT WINCH KIT

- For use with Warn Winch Kit.
- Versatile system that can be easily mounted at the front or rear of the Can-Am Commander.
- Complete with Can-Am plug-and-play front and rear wire harness.
- Ergonomically formed handle makes it easy to carry from front to rear.
- Front 2" (5 cm) Receiver Hitch (715000663) required for installation.
- Integrated receiver allows for use with Multimount Tow (715001142), sold separately.
- Roller Fairlead (715001119) is required for use with synthetic cable winch.

Fits: RU (MAX models only)
715002068

Fits: RU (except MAX models)
715000659



WINCH & HITCH SUPPORT PLATE

- Mounting plate for winch and Front 2" (5 cm) Receiver Hitch (715000663).
- Standard on XT, XT-P and Limited models.

Fits: RU
715000704



MULTIMOUNT TOW

- 1.5" (3.8 cm) bar system, no ball.
- Requires Multimount Winch Kit (715002068, 715000659).

Fits: RU
715001142



2" RECEIVER HITCH

- Heavy-duty 2" (5 cm) receiver hitch.
- Can pull up to 1,300 lb (590 kg).
- Not EC compliant.

Fits: RS (Turbo, X ds Turbo & X rs Turbo 2016 & up models only)
715002517

MOUNTING PLATE FOR WINCH

Fits: RS
715001699

Fits: RS (X mr models only)
(Not illustrated)
• Required with Front Pre-Runner Bumper.
705203196



RUBBER RECEIVER PLUG

- Rubber cap for 2" (5 cm) Receiver Hitch.

705204503



WINCH HARNESS

(Not illustrated)

- Required for all Maverick MY17s and up, since the X mr will be the only model standard-equipped with a winch.
- For front winching only (does not fit the multimount kit for rear hitching).

Fits: RS
710005215

SYNTHETIC WINCH CABLE

- 50' of 7/32" (15.2 m of 5.5 mm) synthetic cable for Warn winch.

• NOTE: Replacing a wire rope with synthetic cable also requires changing the fairlead to avoid damage and wear to the synthetic cable from the rough surface of the old fairlead.

Fits: with Warn winch
715001118



REPLACEMENT WIRE ROPE

- 55' of 7/32" (16.8 m of 5.5 mm) wire rope for Warn winch kit.

Fits: with Warn winch
715001117



SYNTHETIC CABLE EXTENSION

- Lightweight 1/4" (6.3 mm) diameter, easy to handle and won't rattle in cargo box.
- Easily attaches to winch cable to provide additional 50' (15.2 m) of distance.
- 4,500 lb (2,041 kg) single line capacity.

Fits: RS, RU, SSP
715001120



FRONT 2" (5 CM) RECEIVER HITCH

- Can be used with a standard 2" (5 cm) draw bar.
- Complete with integrated quick locking/release pin for easy installation and removal of draw bar.
- Allows for front-mount pulling/pushing or additional accessory attachments, such as a plow.
- Winch & Hitch Support Plate (715000704) is required for installation.
- Not EC compliant.

Fits: RU
715000663



RECEIVER HITCH

- Heavy-duty 2" (5 cm) receiver hitch.
- Can pull up to 1,300 lb (590 kg).
- Not EC compliant.

Fits: RS (except Turbo, X ds Turbo & X rs Turbo 2016 & up models)
715001648 • Black



ROLLER FAIRLEAD

- Suggested when changing the wire rope.
- Heavy-duty replacement fairlead for Warn winch.

Fits: with Warn winch
715001119



WIRELESS REMOTE CONTROL

- The system is quick and easy to install, thanks to a wiring harness with an integrated antenna and all necessary mounting hardware.
- Allows you to operate your winch from anywhere within a 50' (15.2 m) radius, increasing your recovery options.
- All components are weatherproof.

Fits: with Warn winch
715002542





MAVERICK COMMANDER

CATCH THE VIDEO AT CAN-AMOFFROAD.COM



NEW

BEARD SEATS

- True suspension seating for driver and passenger seats.
- Designed specifically for side-by-side vehicle applications.
- Offer great posture for both driver and passenger during intense riding conditions, thanks to the ideal seat angle and pitch.
- Feature a high and unmatched level of containment support, which gives superior comfort and stability.
- The belt notch allows easy seat removal and added comfort for larger occupants.
- Made of rigid welded-steel frame, covered with sculpted foam and wrapped with a custom cover of premium marine-grade vinyl, which is durable in all driving conditions and resistant to mildew and fading.
- Enhances the racing look of the vehicle.
- No additional seat mounts required.
- Sold in pairs.

Fits: RS, RU

- 715003607 - Grey
- 715003609 - Octane Blue
- 715003608 - Manta Green



MAVERICK



YOSHIMURA SLIP-ON EXHAUST

- Developed in collaboration with Yoshimura.
- Made from 304-grade stainless steel.
- Better sounding, better looking and 33% lighter than stock muffler.
- USDF/USDA approved spark arrester.
- Standard on Maverick X rs and Maverick MAX X rs 2016 & up models.
- EPA compliant.
- Not EC compliant.

Fits: RS (Turbo, X ds Turbo, X rs Turbo 2016 & up models)

715003051

CATCH THE VIDEO AT CAN-AMOFFROAD.COM

COMMANDER



YOSHIMURA SLIP-ON EXHAUST

- Developed in collaboration with Yoshimura.
- Made from 304-grade stainless steel.
- Better sounding, better looking and lighter than stock muffler.
- USDF/USDA approved spark arrester.
- Non EPA compliant (for racing application only).
- Not EC compliant.

Fits: RU

715002089

Some products shown may not be available or homologated in your country. Contact your BRP dealer for local details.



MAVERICK COMMANDER



FENDER FLARE

- Fender flare made from injection-molded polypropylene.
- Keeps mud and debris out of vehicle.
- Includes front and rear extensions and all mounting hardware.

Fits: RS
715002414

XT FENDER FLARE

- Delivers aggressive look while providing added protection from dirt and debris.
- Includes front and rear extensions and all mounting hardware.
- Standard on XT, XT-P and Limited models.

Fits: RU
715002451



Keep MUD and debris out of vehicle.



SUPER EXTENDED FENDER FLARE

- Extended Fender Flare made from injection-molded polypropylene.
- Keeps mud and debris out of vehicle.
- Flexible mud flap included.
- Includes front and rear extensions and all mounting hardware.

Fits: RS
715001323

MAVERICK COMMANDER



NEW

LONESTAR RACING FIRE EXTINGUISHER SUPPORT KIT

- Quick release support that allows you to slide the fire extinguisher out in a matter of seconds in an emergency situation.
- Made of billet anodized black aluminum with Lonestar Racing logo engraved.
- Fits 2" (5 cm) tubing.
- Can be fixed everywhere on the cage.
- Adds racing style while providing you with the safety and security of having dependable emergency equipment on board.
- Comes with both billet mounts, quick-pull pin, mounting plate and 2 clamps.
- Fire extinguisher sold separately.
- "Lonestar Racing for Can-Am" branded.

Fits: RS, RU
715003592



FIRE EXTINGUISHER

- Ideal for grease, oil and electrical fires.
- Fits with Lonestar Racing Fire Extinguisher Support Kit.
- Not EC compliant.

295100005 - Red

Note: White color not available.



SNORKEL KIT

- Raises point of engine air intake to cool CVT so vehicle can be semi-submersed in water / mud without taking in water to the engine.
- Not compatible with Rear Nets and Windows, Harness Bars and Cab Enclosures.
- Can be installed on Commander 2012 and up with Dual CVT air Intake (715002467).
- Not EC compliant.
- Used in conjunction with QRS Driven Clutch Upgrade Kit to increase drive belt durability.

Fits: RS (except Turbo, X mr, X ds, X rs 2016 & up & MAX models), RU 2012 & up (except MAX models)
715001728

DUAL CVT AIR INTAKE

- Complete kit to upgrade CVT cover from 1 inlet - 1 outlet to 2 inlets - 2 outlets.
- Needed to install Snorkel Kit (715001728) on Commander 2012 & up.
- Keeps CVT system cooler in extreme use conditions.

Fits: RU 2012 & up (except Limited & MAX models)
715002467



NEW

QRS DRIVEN CLUTCH UPGRADE KIT

- (Not illustrated)
- QRS Driven Clutch Upgrade Kit from X ds Turbo model but calibrated for the 1000R (non-turbo) engine (Standard on X mr 2017 & up models).
 - Increases drive belt durability.
 - Use it with the CVT Ventilation Upgrade Kit (715003044) for improved performance and reliability.

Fits: RS (except Turbo models)
715003045

NEW

CVT VENTILATION UPGRADE KIT

- (Not illustrated)
- CVT inlet with better flow and increased belt ventilation by 10%.
 - Increases drive belt durability (decreases heat).
 - Allows you to get the maximum performance.
 - Requires QRS Driven Clutch Upgrade Kit (715003045).
 - Standard on X ds Turbo models.
 - For use with standard wheel size.

Fits: RS
715003044



NEW

AIR INTAKE PRE-FILTER FOR SNORKEL KIT

- Adds extra protection to your engine in harsh riding conditions.
- Helps keep air filter cleaner.
- Filter blocks particles larger than 0.007" (0.19 mm).
- Easy, tool-less installation.

Fits: RS (X mr models) or in conjunction with Snorkel Kit (715001728)

715003616



DEFENDER



NEW COMING SOON

S3 HIGH CLEARANCE A-ARM FRONT

- Prevents A-arm damage over rough terrain.
- Preserves factory ride quality and turning radius without reducing performance.
- Not compatible with Apache 360 LT Track System and Front A-Arm Protectors.
- "S3 for Can-Am" branded.

Fits: UR

- 715003784 - Black
- 715004222 - Combustion Blue



NEW COMING SOON

S3 HIGH CLEARANCE A-ARM REAR

- Prevents A-arm damage over rough terrain.
- Preserves factory ride quality and turning radius without reducing performance.
- Not compatible with Apache 360 LT Track System and Rear A-Arm Protectors.
- "S3 for Can-Am" branded.

Fits: UR

- 715003785 - Black
- 715004223 - Combustion Blue



MAVERICK COMMANDER

FOAM AIR FILTER BY TWIN AIR[†]

- The best choice for the harshest conditions.
- Multiple staged oiled filtering foam for superior dust retaining capacity with high airflow.
- Washable and reusable.

Fits: RS, RU (except X ds Turbo, Turbo, X rs Turbo 2016 & up models)

715001956

715001956



715002837



FOAM REPLACEMENT

(Not illustrated)

Fits: RS, RU
707800582

Fits: RS (Turbo models only)
707800682

AIR INTAKE PRE-FILTER

- Adds extra protection to your engine in harsh riding conditions.
- Filter blocks particles larger than 0.005" (0.1 mm).
- Necessary to maintain the vehicle warranty when tracks are installed.

Fits: RS (except X mr, X ds Turbo, Turbo, X rs Turbo 2016 & up models), RU
715000953



VALVE FOR DONALDSON AIRBOX

(Not illustrated)

- Ensures engine performance in dry sandy conditions.
- Evacuates sand and dust from airbox.
- Reduces the frequency of airbox cleaning.

Fits: RS (Turbo models only)
715003114

MAVERICK COMMANDER

RADIATOR PROTECTOR

- Black epoxy electrocoated metal shield that mounts over radiator face to provide protection from stones and branches.

Fits: RU

715001126

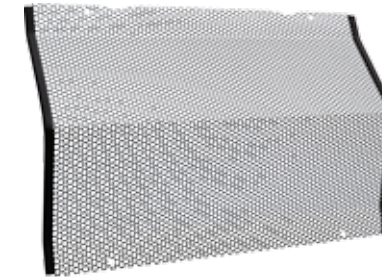

RADIATOR PROTECTOR

- Radiator grill that replaces stock plastic louver.
- Tool-less quick removal renders washing radiator a simple task.
- Made from 5052-grade aluminum.
- Metal shield mounted over radiator face provides protection from stones and branches.

Fits: RS (except X mr models)

715002393



FRONT SHOCK COVERS

- Offer added protection in rough terrain and weather conditions.
- Sold in pairs.

Fits: RU

715001324



SHOCK COVERS

(Not illustrated)

- Soft cover for shocks with ventilation holes.
- Eliminate dust and dirt intrusion into the shock cylinder, reducing risk of damage.
- Sold in pairs.

Fits: RS (except Turbo, X ds, X mr, X rs Turbo 2016 & up models)

715002368

Fits: RS (except XXC, XC, XC DPS models)
715003471

SPORT STEERING WHEEL

- Polyurethane soft-touch black grip highlighted with silver spokes.
- Standard on X, XT, XT Mossy Oak Hunting Edition, XT-P, X rs, X ds, X xc and Limited models.

Fits: RS, RU

715001134



FRONT SWAY BAR

- Enhances vehicle performance and control during hard cornering.
- Standard on XT and XT-P models.

Fits: RU

715001125



FOX PERFORMANCE FRONT SHOCKS

- Fox Piggyback racing shocks.
- Include rebound and high/low speed compression adjustments.
- Sold in pairs.
- Standard on XT and XT-P models.
- Need to be installed with Fox Performance Rear Shocks (715001023).

Fits: RU (except Limited & MAX models)

715001022



FOX PERFORMANCE REAR SHOCKS

- Fox 2.0 Position Sensitive racing shocks.
- Include rebound and high/low speed compression adjustments.
- Sold in pairs.
- Standard on XT and XT-P models.
- Need to be installed with Fox Performance Front Shocks (715001022).

Fits: RU (except Limited & MAX models)

715001023

BEST
YEAR-ROUND
TRACK
SYSTEM
ON THE MARKET



DEFENDER MAVERICK COMMANDER

APACHE 360 LT TRACK SYSTEM

- Highly engineered track system provides ultimate traction in snow and any other type of ground surface for your Can-Am vehicle.
- Front track design reduces vibration, eases turning and enhances performance in any hard packed conditions. The angled front lugs minimize resistance, and the way the lugs overlap over the wheels ensures smooth rolling. The rear track pattern and lug height are balanced for greater traction.
- Unique adjustable contact patch enables you to tackle the toughest conditions year round. This new system has two settings: the user can choose a better attack angle in rough terrain or greater flotation in deep snow.
- Thanks to the heightened rubber over molded heavy-duty double bearing wheels and offset wheel spacing, friction and vibration are reduced to a minimum while ensuring reliability.
- Easy installation and quick conversion from tires to tracks once the Apache 360 LT Mounting Kit is installed (sold separately).
- The DPS module, included in the Apache 360 LT Mounting Kit, optimizes your Dynamic Power Steering (DPS) performance, maximizing steering agility at lower speeds while providing firmer steering at cruising speeds. It also provides a speed correction factor for the speedometer.
- Heavy-duty components ensure reliability and the design offers excellent acceleration, turning, braking and side-hilling performance.
- Larger contact patch than the Apache 360 Track System by 15 in² (97 cm²) at front and 41 in² (265 cm²) at back.
- Higher ground clearance than the Apache 360 Track System by 3/4" front and 1.25" rear.
- Higher rear angle of attack.
- Apache 360 LT Mounting Kit is required.
- EC compliant.

Fits: UR, RU, RS
715003064

APACHE 360 LT MOUNTING KIT

(Not illustrated)

- Required to install Apache 360 LT Track System (715003064).

Fits: UR
• Air intake pre-filter is included.
715002427

Fits: RS (except X ds Turbo, X rs Turbo 2016 & up models)
715003013

Fits: RU
• DPS module is included for Commander 2013 and up.
• EC compliant.
715003062

Fits: UR, RS (X ds Turbo, X rs Turbo 2016 & up models only)
715003478

AIR INTAKE PRE-FILTER

- Adds extra protection to your engine in harsh riding conditions.
- Filter blocks particles larger than 0.005" (0.1 mm).
- Necessary to maintain the vehicle warranty when tracks are installed.

Fits: RS (except X mr, X ds Turbo, Turbo, X rs Turbo 2016 & up models), RU
715000953



NEW

AIR INTAKE PRE-FILTER

- Adds extra protection to your engine in harsh riding conditions.
- Helps keep air filter cleaner.
- Filter blocks particles larger than 0.007" (0.19 mm).
- Easy, tool-less installation.
- Included in the Apache 360 LT Mounting Kit (715002427).

Fits: UR
715003483



HIGHLY ENGINEERED TRACK DESIGN PROVIDES ULTIMATE TRACTION IN ANY TERRAIN AND LOWEST STEERING EFFORT.

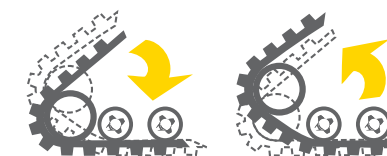

Unique adjustable contact patch system to tackle the toughest year-round conditions.



Easy installation and quick conversion from tires to tracks.



Rubber over molded heavy-duty double bearing wheels and offset wheel spacing reduce friction and vibration while ensuring reliability.



DEFENDER MAVERICK COMMANDER

72" (183 CM) ALPINE FLEX PLOW KIT

- 72" (183 cm) blade made of flexible high-impact-resistant UHMW thermoplastic.
- Impressive flexibility prevents plow damage during accidental impacts.
- Impact absorption properties return blade to its original shape.
- Rearward release action greatly reduces transmission of impact to driver or unit.
- Fast and easy attach/detach mounting system.
- Conveniently-placed blade-turning mechanism eliminates having to bend down to adjust blade angle.
- High-pivot design keeps plow on surface.
- Compatible with all Alpine Flex Plow accessories to further enhance plow versatility.
- Includes Plow Roller Fairlead and cable saver limit switch.

THIS KIT INCLUDES

72" (183 cm) Alpine Flex Plow (715001972), Alpine Flex Plow Push Frame (715002461), Alpine Flex Plow Mounting Kit (715002460) Fits: UR 715003108	72" (183 cm) Alpine Flex Plow (715001972), Alpine Flex Plow Push Frame (715001992), Alpine Flex Plow Mounting Kit (715001957) Fits: RU 715003150	72" (183 cm) Alpine Flex Plow (715001972), Alpine Flex Plow Push Frame (715002461), Alpine Flex Plow Mounting Kit (715003524) Fits: RS 715003545
---	---	---



ALPINE FLEX PLOW ACCESSORIES

ALPINE FLEX PLOW PUSH FRAME EXTENSION

(Not illustrated)
• Extension for Alpine Flex Plow Push Frame for use with the Apache 360 LT Track System.

Fits: UR, RU, RS (except X rs Turbo 2016 & up models)
715001973

8" (20 CM) ALPINE FLEX PLOW EXTENSIONS

(Not illustrated)
• These conveniently extend your Alpine Flex Plow.

Fits: Alpine Flex Plow
715001385

ALPINE FLEX PLOW RUBBER FLAP

(Not illustrated)
• Keeps snow away from the driver.
• Minimizes snow flowing over plow.
• Increases snow rolling effect.

Fits: 72" (183 cm) Alpine Flex Plow
715002117

ALPINE FLEX WEAR BLADE (PLASTIC)

(Not illustrated)
• Flexible UHMW plastic construction won't scratch your driveway.
• Replaces stock wear blade.

Fits: 72" (183 cm) Alpine Flex Plow
715002120

ALPINE FLEX WEAR BLADE (STEEL)

(Not illustrated)
• Long-lasting wear blade that provides a sharper cut.
• Replaces stock wear blade.

Fits: 72" (183 cm) Alpine Flex Plow
715002121

ALPINE FLEX DRIFT CUTTER

(Not illustrated)
• Keeps snow securely in the plow.
• Fits on either left or right side.
• Sold individually.
• Requires 8" (20 cm) Alpine Flex Plow Extensions (715001385).

Fits: Alpine Flex Plow
715001386

ALPINE FLEX PLOW EDGE MARKERS

(Not illustrated)
• For a more accurate view of the width of your plow so you avoid damaging your curb, your car or your house.

Fits: Alpine Flex Plow
715001388

Some products shown may not be available or homologated in your country. Contact your BRP dealer for local details.

DEFENDER COMMANDER

72" (183 CM) SUPER-DUTY PLOW KIT

- A comprehensive plow system with manual lift and angling.
- Ultra-durable 72" (183 cm) blade made of 12-gauge steel with integrated reinforcement and heavy-duty push tubes to tackle the most demanding jobs.
- Requires a winch for raising and lowering.
- Convenient disconnect system for quick and easy installation or removal.
- Front mount provides minimum 11" (28 cm) lift distance.

THIS KIT INCLUDES

72" (183 cm) Super-Duty Plow (715001292) Super-Duty Plow Push Frame (715001293) Super-Duty Plow Mounting Kit (715002731) Fits: UR 715003416	72" (183 cm) Super-Duty Plow (715001292) Super-Duty Plow Push Frame (715001293) Super-Duty Plow Mounting Kit (715001294) Fits: RU 715001140
--	--



SUPER-DUTY PLOW ACCESSORIES

SUPER-DUTY PLOW HYDRAULIC ANGLING KIT

- Allows you to have full up/down and left/right plow control at your fingertips.
- Pre-assembled, it comes with everything you need to turn your Commander and Commander MAX Super-Duty Plow into a quick, easy-to-control unit from the driver's seat.
- Using one hand to control all plow motions with the supplied joystick will allow you to easily concentrate and manage your plowing tasks.
- With this commercial grade kit, you will send snow exactly where you want reliably all winter long.
- Winch and plow sold separately.

Fits: UR, RU
715002840



Dual cylinders hydraulic



Electric hydraulic unit

PLOW BLADE EXTENSIONS

- Side extensions for widening your plow blade by 6" (15 cm) on each side.
- Include rubber flaps for extension parts.
- Sold in pairs.

Fits: Super-Duty Plow
715001217 • Black



WARN[†] PLOW ROLLER FAIRLEAD

- Larger diameter lower roller reduces wear on wire rope for plow application.
- For use with Super-Duty Plow.

Fits: Super-Duty Plow
715001223



SUPER-DUTY PLOW PUSH FRAME EXTENSION

- (Not illustrated)
• Extension to use the Super Duty Plow with the Apache 360 LT Track System.
• Comes with Plow magnetic switch (715001995) and plow pulley (715002042).
• Requires Front Bumper or Front Accessory Bar for installation.

Fits: Super-Duty Plow
715001221 • Black

PLOW EDGE MARKERS

- (Not illustrated)
• For a more accurate view of the width of your plow.
• Allows you to work closely around objects.

Fits: Super-Duty Plow
715001216

PLOW DRIFT CUTTER

- (Not illustrated)
• Keeps snow securely in the plow.
• Allows you to cut a cleaner pass.
• Sold individually.

Fits: Super-Duty Plow
715001218 • Black

PLOW RUBBER FLAP

- (Not illustrated)
• Keeps snow away from the driver and helps snow to roll in front of the plow.

Fits: Super-Duty Plow
715001219

PLOW PULLEY

- (Not illustrated)
• For use with the Super-Duty Plow.
• Helps winching efficiency.
• Requires Front XT Bumper.

Fits: Super-Duty Plow
715002042

PLOW MAGNETIC SWITCH

- (Not illustrated)
• Magnetic switch that stops the winch to prevent cable, winch and frame damage.
• For use with Super-Duty Plow.

Fits: Super-Duty Plow
715001995

DEFENDER MAVERICK COMMANDER



715003393

715001369

715001025

715001368

TRAILERING COVERS

- Can-Am branded 300-denier solution-dyed, water-repellent polyester construction.
- Allow access to fuel, cargo box, and passenger compartment.
- Heavy-duty elastic strap around bottom for secure fit.
- Lined with soft fabric in the windshield area to prevent scratching.

- Fits with or without roof, light rack, front and rear bumpers, side mirrors and Baja-Style Spare Tire Holder.

Fits: RS (except MAX models)

715001655 • Black

Fits: RS 2014 & up (MAX models only)

715002103

- Fits with or without roof, light rack, front rack, light protector, front and rear bumpers, and side mirrors.

Fits: RU (except MAX models)

715001025

Fits: RU 2014 & up (MAX models only)

715001963

Fits: UR (except MAX models)

NEW 715001369 • Black

Fits: UR (MAX models only)

NEW 715003393

STORAGE COVERS

- Can-Am branded 100-denier solution-dyed, water-repellent polyester construction.
- Fit with or without most accessories.
- Heavy-duty elastic strap around bottom and polypropylene webbing across bottom for secure fit.

Fits: RU (except MAX models)

715001368 • Black

ANTI-POOLING POLES

- 8 mm fiberglass poles to prevent snow or rain from accumulating on your trailer cover.
- Sold in pairs.
- Comes with nylon bag.
- Not for use while trailering.

Fits: RS, RU

715001374



LICENSE PLATE HOLDER

- Supports your license plate.

Fits: RU

715001326

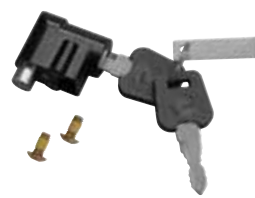

LOCK FOR TAILGATE

- Device locks lower tailgate.
- Includes key.

Fits: RU

715001127



WORK KEY

- Key limits vehicle speed to 25 mph (40 km/h) for use on construction sites.

Fits: RS, RU

715001201



LOCKABLE GAS CAP

- Protects your fuel.
- Meets EPA requirements.

Fits: RS, RU

715001124



12 V POWER OUTLET

- 12 V accessories outlet.
- Easy plug-in harness included.

Fits: RS

715001650

Fits: RU, UR (on base & DPS models)
715001321

ACCESSORY TIRES

ZILLA TIRE BY MAXXIS*

- Sold individually.

Front

27" x 10" x 14"

705401302

Rear

27" x 12" x 14"

705501703



NEW

ITP TERRACROSS TIRE

- This smooth-riding tire will command every bit of traction from the ground while still managing to float across loose snow, sand and mud.
- Features extreme-duty construction for improved puncture protection, extra-tough rubber compound for increased tread life, and the interlocking tread pattern and wide footprint make it one of the toughest and grippiest radials around.
- Not EC compliant.

Fits: G2 (DPS models except G2L), G2 (XT models except G2L, XT-P & Limited)

Front

26" x 8" x 14"

705401906

Rear

26" x 10" x 14"

705502421



OEM TIRES



GORILLA SILVERBACK TIRE

- AT30X9-14 Gorilla Silverback mud tire.
- Sold individually.
- Not EC compliant.

Fits: G2 (850 & 1000 models only)

30" x 9" x 14"

705400962



MAXXIS MUDZILLA TIRE

- Not EC compliant.

Fits: G2 (X mr 570 & 650 models only)

Front

28" x 8" x 12"

705401391

Rear

28" x 10" x 12"

705501836



CARLISLE ACT TIRE

Fits: G2 (500-1000 XT models only)

Front

26" x 8" x 12"

705401333

705401334 •

Rear

26" x 10" x 12"

705501769

705501770 •

Fits: G2 (400 XT models only)

Front

25" x 8" x 12"

705400606

705400326 •

Rear

25" x 11" x 12"

705500933

705500598 •



CARLISLE BLACK ROCK TIRE

Fits: RU (Base models only)

Front

27" x 9" x 12"

705400781

Rear

27" x 11" x 12"

705501129



CARLISLE BADLANDS A/R TIRE

Fits: G2 (500-1000 Base models only)

Front

26" x 8" x 12"

705401331

705401332 •

Rear

26" x 10" x 12"

705501767

705501768 •



CARLISLE TRAIL WOLF TIRE

Fits: G2 (400 Base models only)

Front

25" x 8" x 12"

705401625

705400607 •

Rear

25" x 11" x 12"

705502164

705502165 •



ITP HOLESHOT ATR TIRE

Fits: G2S

Front 205/80R12

25" x 8" x 12"

705400600

705400475 •

Rear 270/60R12

25" x 10" x 12"

705500926

705500820 •

*Consult your operator's guide/owner's manual for proper tire type and rim sizing. Improper tire type and rim selection may affect vehicle handling. Check with your local authorities for proper regulation.

Some products shown may not be available or homologated in your country. Contact your BRP dealer for local details.

OEM TIRES

DURO THRASHER TIRE

Fits: DS 90/70
Front - 19" x 7" x 8"
V42711DGF00LL



Rear - 18" x 9.5" x 8"
V42712DGF010LL

KENDA KLAW MXR TIRE

Fits: DS 90 X
Front - 20" x 6" x 10"
V42711DGF01HLL



Rear - 18" x 10.5" x 8"
V42712DGF01HLL

ITP HOLESHOT SR TIRE

Fits: DS 450
Front - 21" x 7" x 10"
705400432



Rear - 20" x 10" x 9"
705500787

ITP QUADCROSS MX PRO TIRE

Fits: DS 450 X mx
Front - 20" x 6" x 10"
705400765



Rear - 18" x 10" x 8"
705501106

ITP HOLESHOT GNCC TIRE

Fits: DS 450 X xc
Front - 21" x 7" x 10"
705400650



Rear - 20" x 10" x 9"
705500989

KENDA KNARLY TIRE

Fits: DS 250
Front - 22" x 7" x 10"
S44710RCA000



Rear - 20" x 11" x 9"
S42710RCA000

REAR TIRE CHAINS

• Improve your traction in mud and snow.
• Sold in pairs.
26" x 10" x 12"
715500218



25" x 10" x 12"
715000225

NEW

MAXXIS M923J / M924J

Fits: UR (Base and DPS models only)
Front - 25 x 8 x 12
705401658



Rear - 25 x 10 x 12
705502215

OEM TIRES

MAXXIS BIGHORN 2.0 TIRE

Fits: RU (except XT-P & Base models), UR (XT, XT Cab)

Front 27" x 9" x 14" 705401377 705400961 - €€	Rear 27" x 11" x 14" 705502019 705501295 - €€
--	--



Fits: RS, RU (XT-P & Base models only)

Front 27" x 9" x 12" 705401385 705401386 - €€	Rear 27" x 11" x 12" 705501817 705501818 - €€
--	--

Fits: RU, RS, SSP 64" Standard

Front 28" x 9" x 14" 705401592	Rear 28" x 11" x 14" 705502144
--------------------------------------	--------------------------------------



NEW

X DS TIRE - MAXXIS BIGHORN

Front - 29" x 9" x 14" 705401674	Rear - 29" x 11" x 14" 705502225
-------------------------------------	-------------------------------------



NEW

X RS FRONT AND REAR TIRE - MAXXIS BIGHORN

Front & Rear - 30" x 10" x 14"
705401718

OEM RIMS & BEADLOCK FOR SIDE-BY-SIDE VEHICLES

NEW

X MR AND DEFENDER RIM

• Cast aluminum rim with trend setting explosive styling so you can ride - and look - like a trailblazer.
• Front: 14" x 6.5" offset = 10 mm

Fits: UR (front wheels), ATV, SSV (X mr models front & rear wheels)

■ 705401848 - Black and machined
■ 705401849 - Black



NEW

DEFENDER RIM

• Cast aluminum rims with trend setting explosive styling so you can ride - and look - like a trailblazer.
• Rear: 14" x 8.5" offset = 23 mm

Fits: UR (rear wheels)

■ 705502397 - Black and machined
■ 705502398 - Black



NOTE: Matching Nuts - 250100100 Black, 250100082 Chrome / Matching Cap - 705401541

14" MAVERICK X DS RIM

• Black with clear coat aluminum rim.
• Choice of beadlock color (not included).
• Needs 16 bolts (250000435) for installing the beadlock.

Fits: RS, RU

Front - 14" x 6.5" offset = 41 mm 705401594	Rear - 14" x 8" offset = 51 mm 705502146
--	---



12" MAVERICK RIM

• Black with clear coat aluminum rim.
• Choice of beadlock color (not included).
• Needs 16 bolts (250000435) for installing the beadlock.

Fit: RS

Front - 12" x 6" 705401678 - Black	Rear - 12" x 7.5" 705502244 - Black
------------------------------------	-------------------------------------



14" X DS BEADLOCK

• Cast aluminum beadlock.
• Must be installed on Front Rim (705401594) and Rear Rim (705502146).

Fits: RS, RU

■ 705401586 - Manta Green
■ 705401702 - Octane Blue
■ 705401837 - Can-Am Red

12" MAVERICK BEADLOCK

• Cast aluminum beadlock.
• Must be installed on Front Rim (705401678) and Rear Rim (705502244).

Fits: RS

■ 705401445 - Can-Am Red
■ 705401543 - Orange Crush
■ 705401329 - Yellow
■ 705401695 - Octane Blue

NOTE: Matching Nuts - 250100100 / Matching Cap - 705400928

OEM RIMS & BEADLOCK FOR SIDE-BY-SIDE VEHICLES

LIMITED 14" RIM

- Premium cast aluminum rim.
- Black with machined face.
- Sold individually.
- Standard on Limited model.

Fits: **RS, RU**

Front - 14" x 7" offset = 41 mm

705501813 - Silver/Black

Rear - 14" x 8.5" offset = 51 mm

705401380 - Silver/Black



XT 14" RIM

- Premium cast aluminum rim.
- Sold individually.
- Standard on XT Camo models.

Fits: **RS, RU**

Front - 14" x 7" offset = 41 mm

705401379 - Black

705400632 - Silver with clear coat

Rear - 14" x 8.5" offset = 51 mm

705501814 - Black

705501812 - Silver with clear coat



NOTE: Matching Nuts - 250100100 Black & 250100082 Chrome / Matching Cap - 705400680 Black

OEM RIMS FOR ATV

ATV: G2 DPS, G2 XT, G2 MAX 650, G2 MAX XT, G2 MAX Limited

NEW

14" RIM

- Premium cast aluminum black painted with machining and clear coat rim.
- Center hole: 72 mm
- Bolt circle pattern: 4/136 mm

Front - 14" x 6.5" offset = 40 mm

705401853 - Black and machined

Rear - 14" x 8.5" offset = 50 mm

705502402 - Black and machined



NEW

14" RIM

- Premium cast aluminum rim.
- Center hole: 72 mm
- Bolt circle pattern: 4/136 mm

Front - 14" x 6.5" offset = 40 mm

705401852 - Black with clear coat

705401851 - Silver with clear coat

Rear - 14" x 8.5" offset = 50 mm

705502401 - Black with clear coat

705502400 - Silver with clear coat



NOTE: Matching Nuts - 250100100 Black, 250100082 Chrome / Matching Cap - 705400928

COLORED FINS FOR RIMS

- Plastic fins that enhance the appearance of your vehicle.

Fits on following rims:
XT, XT-P and Limited 2016
 (705500986, 705501015,
 705501019, 705400687,
 705400648, 705400683)

705400681 - Yellow

705400950 - Steel Grey



XTR CUSTOM RIM KIT

- Custom Can-Am XTR branded 12" painted aluminum rims.
- Includes matching chrome nuts and center covers.
- Set of 4.

Fits: **G2, G2S 2012 & prior**
(with 650 or 800R engine)

Front - 12" x 6"

Rear - 12" x 8"

715000611 - Black



Some products shown may not be available or homologated in your country. Contact your BRP dealer for local details.

OEM RIMS & BEADLOCK FOR ATV

RENEGADE X XC & OUTLANDER XTP RIM

- Black with clear coat aluminum rim.
- Needs 16 bolts (250000435) for installing the Beadlock.
- Choice of beadlock color (not included).

Fits: **G2, G2L, G2S**

Front - 12" x 6"

705401678 - Black

Rear - 12" x 7.5"

705502244 - Black



BEADLOCK

- Cast aluminum beadlock.
- Must be installed on Front Rim (705401678) and Rear Rim (705502244).

Fits: **G2, G2L, G2S**

705401156 - Yellow

705401533 - Orange Crush

705401812 - Manta Green

OUTLANDER RIM (CAMO MODEL)

- Black with clear coat aluminum rim.

Fits: **G2, G2L, G2S**

Front - 12" x 6"

705401127 - Black with clear coat

Rear - 12" x 7.5"

705501493 - Black with clear coat



NOTE: Matching Nuts - 250100100 / Matching Cap 705400928



ACCESSORY RIMS FOR ATV & SIDE-BY-SIDE VEHICLES



RED LABEL BLACK RIM BY DWT*

- Sold individually.

Front - 12" x 8"

Bolt circle pattern: 4/136 mm

Wheel offset: 4 + 4

705401261

Rear - 12" x 10"

Bolt circle pattern: 4/136 mm

Wheel offset: 5 + 5

705501717



LOCKOUT 393 14" RIM BY VISION*

- Sold individually.

• Matching Cap (705401362), Matching Nuts (250100100).

Front - 14" x 7"

Bolt circle pattern: 4/136 mm

Wheel offset: 4 + 3

705401363

Rear - 14" x 8"

Bolt circle pattern: 4/136 mm

Wheel offset: 4 + 4

705501787



OUTLANDER X MR RIM - ITP-SS212*

- Sold individually.

• Black with machining and clear coat rim.

• Matching Cap (705400963), Matching Nuts (250100100).

• Sold individually.

Fits: **G2 (X mr models only)**

Front & Rear - 14" x 6"

705400877 - Black and machined

*Consult your operator's guide/owner's manual for proper tire type and rim sizing. Improper tire type and rim selection may affect vehicle handling. Check with your local authorities for proper regulation.



LADIES' RIDING JACKET
P. 202



XP-3 X-RACE HELMET
P. 186



MOSSY OAK CAMO JACKET & PANTS
P.198



SPORTSWEAR

Wear your heart on your sleeve, or at the very least your love of everything Can-Am. Our sportswear is where you'll find the perfect blend of technical excellence, versatility, comfort and great looks.

- 178 Men's
- 182 Ladies'
- 183 Teen & Kidswear



HELMETS & GOGGLES

Comfort and security. That's what it's all about. There's a lot to choose from, so it won't be hard to find a helmet that suits your needs and the right goggles that'll see you through every exciting Can-Am day.

- 184 Cyclops Gear Cameras
- 185 Cross Helmets
- 190 Which Cross Helmet is for you?
- 192 Open Face / Full Face Helmets
- 193 Bluetooth Communication Systems
- 194 Goggles



RIDING GEAR

Rugged, reliable and ready for just about anything you can throw at them. That's what we've engineered into all our riding gear. It's guts and glory, pride and that powerful can do Can-Am attitude that'll get you there, and get things done.

- 196 Gloves
- 197 Jerseys
- 198 Jackets & Pants
- 198 Boots
- 205 Technology Guide
- 206 Technical Wear
- 208 Bags
- 209 Sizing Chart



NEW

ZIPPED HOODIE

- Full-zip hooded sweatshirt.
- 2 chest pockets.
- Ribbed waistband and cuffs.
- Can-Am print on hood with contrasting hood cords.
- Checkered print on sleeves (black model only).

60% Cotton, 40% Polyester

286620

S, M, L, XL, 2XL, 3XL
Khaki (05), Black (90)



MOSSY OAK CAMO FLEECE

- Full-zip fleece with hand warmer pockets.
- Mossy Oak Break-Up Country Camo fabric matches ATV/Side-by-side pattern.

100% Polyester

286589

M, L, XL, 2XL, 3XL
Mossy Oak Break-Up Country Camo (37)



IMPULSE HOODIE

- Ribbed waistband and cuffs.
- Contrasting inner hood.
- Kangaroo front pocket.

60% Cotton, 40% Polyester Fleece

286575

S, M, L, XL, 2XL, 3XL
Beige (02), Heather Grey (27)



OVERSHIRT

- Plaid flannel overshirt.
- Slightly insulated.
- Front opening with press buttons.
- 2 chest pockets.

100% Cotton

286587

S, M, L, XL, 2XL, 3XL
Black (90)



WILD X-TEAM HOODIE

- Full-zip hooded sweatshirt.
- Ribbed waistband and cuffs.
- Non-fading sublimated graphics.
- 2 hand pockets.

100% Polyester

286576

S, M, L, XL, 2XL, 3XL
Blue (80), Black (90)



X-TEAM FLEECE

- High-filament polyester with slight brushed finish for added softness and warmth.
- Spandex content enhances mobility.
- Ideal as a warm, dry first layer.
- Full-zip.
- Welded chest pocket.

95% Polyester, 5% Spandex

286568

S, M, L, XL, 2XL, 3XL
Charcoal Grey (07)



TECHNICAL FLEECE

- Waterproof, windproof and breathable full-zip soft shell.
- Fleece interior for ultimate comfort.
- Pre-shaped sleeves.
- 2 zippered pockets.
- 3M reflective print and piping.

100% Polyester

286330

S, M, L, XL, 2XL, 3XL
Black (90)



LONG SLEEVE FLANNEL SHIRT

- Plaid flannel shirt.
- Chest pockets.

100% Cotton

286584

S, M, L, XL, 2XL, 3XL
Grey (09)





NEW

X-TEAM TEE

• Print at sleeve and front.
100% Cotton
286618
S, M, L, XL, 2XL, 3XL
White (01), Black (90)



SIGNATURE TEE

100% Cotton
286320
S, M, L, XL, 2XL, 3XL
White (01), Khaki (05),
Black (90)



ORIGINAL TEE

100% Cotton
286402
S, M, L, XL, 2XL, 3XL
Heather Grey (27),
Ice (38), Black (90)



TECHNICIAN SHIRT

• Large X-Team embroidery at upper back.
• Pleat at back center for ease of movement.
• Chest pocket.
65% Polyester, 35% Cotton
286566
S, M, L, XL, 2XL, 3XL
Charcoal Grey (07),
Black (90)



TRACK TEE

100% Cotton
286574
S, M, L, XL, 2XL, 3XL
Red (30),
Blue (80),
Black (90)



LONG SLEEVE ORIGINAL TEE

100% Cotton
286415
S, M, L, XL, 2XL, 3XL
Heather Grey (27),
Ice (38), Black (90)



NEW

X-RACE CAP

• Adjustable plastic back strap.
• Flat peak.
• Can-Am embroidery and X-Team print on peak.
100% Cotton

286613 • One size • Charcoal Grey (07), Blue (80)

TRACK CAP

• Fitted stretch twill cap.
• Flat peak.
97% Cotton, 3% Spandex
286573
S/M, L/XL
Red (30), Blue (80),
Black (90)



MOSSY OAK CAMO CAP

• Matches ATV/Side-by-side Mossy Oak Break-Up Country Camo pattern.
• Front Can-Am embroidery.
• Metal adjuster with BRP logo.
100% Polyester
286548 • One size • Mossy Oak Break-Up Country Camo (37)



ORIGINAL CAP

• Metal adjuster with BRP logo.
100% Cotton
286401
One size
Beige (02), Orange (12),
Black (90)



CLASSIC CAP

• Ultra comfortable, stretch, lightweight fabric.
• Metal adjuster with BRP logo.
72% Polyester, 23% Rayon, 5% Spandex
286210 • One size • Black (90)



RANCH CAP

• Metal adjuster with BRP logo.
• Water-resistant waxed cotton.
100% Cotton
286564
One size
Beige (02), Brown (04)



SUMMER BEANIE

• Lightweight, plaid textured knitted beanie.
95% Cotton, 5% Spandex
286323
One size
Charcoal Grey (07), Black (90)



BANDANA

• Light and comfortable.
• Multiple wear options.
80% Polyester, 20% Cotton
286347
One size
Mixed Color (18),
Black with graphics (94)



**LADIES' X-TEAM TEE**

• V-neck.
95% Cotton, 5% Spandex
286567 • XS, S, M, L, XL, 2XL • White (01), Black (90)

**LADIES' IMPULSE TANK TOP**

• Contrasting binding at collar and armholes.
• Can-Am print at back.
95% Cotton, 5% Spandex
286482 • XS, S, M, L, XL, 2XL • Camo (37), Black (90)

**LADIES' ZIPPED MICRO-POLYESTER**

• Feminine cut.
• 2 zippered pockets.
95% Polyester, 5% Spandex
286565 • XS, S, M, L, XL, 2XL • Charcoal Grey (07)

KIDS' BLOCK TEE

• Can-Am print on back shoulder.
100% Cotton
286472
2, 3-4, 5-6
Blue (80)

**BOY CHASE TEE**

• Can-Am print at back.
100% Cotton
286489
7-8, 10-12, 14-16
Red (30), Black (90)

**GIRL CAN-AM HOODIE**

• Can-Am print at back.
72% Cotton, 23% Polyester,
5% Spandex
286486
7-8, 10-12, 14-16
Purple (40)

**CAN-AM JUNIOR TRAIL GOGGLES BY SCOTT**

• Integrated custom painted frame and strap graphics.
• No Fog¹ anti-fog lens treatment.
• 100% Plastic UV protected clear Lexan¹ lens.
• Multi-layer face foam.
• Durable anti-slip strap.



447898 • One size • Black with graphics (94)

JUNIOR HELMETS*

• High-tech, lightweight and tough.
• Fully-adjustable aero-tuned peak.
• Moisture-wicking and breathable chin strap, liner and cheek pads.
• Ventilation system.

• Easily removable and washable liner and cheek pads.
• Provide maximum visibility.
• Fit all goggles.
• Strap grip to hold goggles strap in place.

• D.O.T. certified.
• Breath deflector mask included.
• Available with clear-coated bold waterslide graphics.
Shell: ABS

JUNIOR CROSS X-1 GRAFFITI HELMET

447989
S, M, L
Black with graphics (94)

DOT

**JUNIOR X-1 BLAZE HELMET**

447673
S, M, L
Orange (12)

DOT

**TEEN RACE JERSEY**

• Quick-dry, antibacterial and moisture-wicking fabric.
• Extended back for riding position.
• Unisex non-fading sublimated print.
100% Polyester
286464
7-8, 10-12, 14-16
Red (30)

**TEEN RACE PANTS**

• Lightweight and extremely breathable pants.
• Overall water-repelling Teflon¹ treatment.
• Debossed fullgrain leather inner knees for heat and abrasion resistance.
• Non-fading sublimated graphics.
• Stretch panel at crotch, knees, side waist, upper back and lower back leg for ease of movement.
• Rubberized elastic waist to hold jersey in place.
• Ratchet style waist closure for better adjustment.
• Straight hem at leg opening for more comfort inside boots.
• 3/4 length mesh lining.
94% Polyester, 6% Leather
286493
7-8, 10-12, 14-16
Red (30)

**TEEN TEAM RIDING GLOVES**

• Spandex construction for great flexibility.
• Direct-injection patches on back hand.
• Chamude¹ palm.
• Pre-curved design.
• Hook-and-loop wrist closure system.
Spandex, Chamude, Nylon, Polyester
286465
6-8, 10-12, 14-16
Red (30)





A BRAND NEW VIDEO EXPERIENCE! THE NEW CG360 CAMERA BY CYCLOPS GEAR.

You control what you see and can capture everything around you!

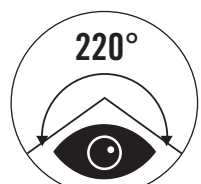

220° ULTRA WIDE ANGLE LENS



1080P 60FPS



MAGNETICALLY MOUNTED



WI-FI CONNECTION



APP SUPPORT VR



WATERPROOF 98.4 FT (30 M)

NEW

CYCLOPS 360 PANORAMIC CAMERA

- 220° ultra-wide angle lens.
- 4K HD and 1080p at 60FPS.
- 12MP photo resolution.
- Compact design facilitates carriage, handling and storage.
- Standard accessories include 32GB Micro SD Card Class 10 and Waterproof Case.
- Free wifi and VR support app for your IOS and Android smartphone or tablet.

9700020090



CGX2 CAMERA

- 4K HD and 1080p at 60fps.
- 2" LCD display screen.
- Waterproof housing up to 165 ft (50 m) underwater and 2.4gh waterproof remote.
- Comes with 32GB Micro SD Card Class 10 and 9 mounts.
- WIFI available to control your camera from your smartphone or tablet with the free iCyclops App for IOS and Android.

2866860090

NEW

CGX2 CHARGER KIT PACK

(Not illustrated)
469296 • One size

NEW

USB AC CHARGER

(Not illustrated)
970001 • One size

NEW

CGX2 EXTRA BATTERY

(Not illustrated)
469297 • One size

NEW

32GBSD CARD

(Not illustrated)
469295 • One size

CROSS HELMETS*

For warmer riding conditions and more active riding, you might want to opt for a cross helmet with goggles. In highly active riding where you will be sweating and breathing hard, goggles are the best solution for clear vision, and the extra open area will keep you from overheating.

XP-R2

ULTRA LIGHTWEIGHT AND STRONG MULTI-DIRECTIONAL CARBON FIBER CONSTRUCTION WITH PREMIUM STYLE AND DETAILS.



XP-R2 CARBON LIGHT ORIGINAL HELMET

Shell: Carbon Fiber Composite
447830
XS, S, M, L, XL, 2XL, 3XL
White (01)

DOT ECE22.05



XP-R2 CARBON LIGHT HELMET

Shell: Carbon Fiber Composite
447656
XS, S, M, L, XL, 2XL, 3XL
Black (90)

DOT ECE22.05



XP-R2 CARBON LIGHT BLAZE HELMET

Shell: Carbon Fiber Composite
447657
XS, S, M, L, XL, 2XL, 3XL
Orange (12)

DOT ECE22.05

XP-R2 MORPHO KIT

- For a perfect custom fit.
- Left and right pads included.

447754
XS, S, M, L, XL, 2XL, 3XL - Clear (00)



WHICH CROSS HELMET IS FOR YOU? SEE COMPLETE DETAILS ON P.190-191



XP-3

SUPERLIGHT CROSS-STYLE HELMET: FEATURE-PACKED FOR EXCEPTIONAL PERFORMANCE, PROTECTION AND COMFORT.

NEW

XP-3 X-RACE HELMET

• Durable multi-colored clear-coated graphics.
Shell: Fiberglass
448395 • XS, S, M, L, XL, 2XL • Orange (12), Blue (80)

DOT Snell ECE22.05



XP-3 HELMET

Shell: Fiberglass
448253
XS, S, M, L, XL, 2XL
Matte Black (93)

DOT Snell



WHICH CROSS HELMET IS FOR YOU? SEE COMPLETE DETAILS ON P.190-191

Some products shown may not be available or homologated in your country. Contact your BRP dealer for local details.



XC-4

PREMIUM LOOK & STYLE.

XC-4 MODERN HERITAGE HELMET

Shell: Polycarbonate Composite
448251 • XS, S, M, L, XL, 2XL • White (01), Grey (09)

DOT Snell

ECE VERSION (Not available in NA)
448340 • XS, S, M, L, XL, 2XL • White (01)

ECE22.05



NEW

LADIES' XC-4 HELMET

Shell: Polycarbonate Composite
448397 • XS, S, M, L, XL, 2XL
Pink (36)

DOT ECE22.05



XC-4 HELMET

Shell: Polycarbonate Composite
448255
XS, S, M, L, XL, 2XL
Black (90)

DOT Snell



WHICH CROSS HELMET IS FOR YOU? SEE COMPLETE DETAILS ON P.190-191



X-1

PACKED WITH FEATURES AT AN UNBEATABLE PRICE.

NEW

X-1 ZONE HELMET

• Fully-adjustable aero-tuned peak.
Shell: ABS
448387 • XS, S, M, L, XL, 2XL • Blue (80), Black (90)

DOT



X-1 HELMET

Shell: ABS
447942
XS, S, M, L, XL, 2XL
Matte Black (93)

DOT



X-1 CROSS MISSION HELMET

Shell: ABS
447991 • ECE
XS, S, M, L, XL, 2XL
White (01), Yellow (10), Orange (12)

ECE22.05



WHICH CROSS HELMET IS FOR YOU? SEE COMPLETE DETAILS ON P.190-191

Some products shown may not be available or homologated in your country. Contact your BRP dealer for local details.



ENDURO

THE NAME SAYS IT ALL. DESIGNED FOR LONG RIDES AND HIGH ADVENTURE.

ENDURO CAMO HELMET

Shell: Polycarbonate Composite
448282
S, M, L, XL, 2XL, 3XL
Camo (37)

DOT ECE22.05



ENDURO HELMET

Shell: Polycarbonate Composite
448259
S, M, L, XL, 2XL, 3XL
Matte Black (93)

DOT ECE22.05



DUST MASKS

- Easily replaceable filters remove 99.9% of airborne dust, particles, pollen and odors.
- Made from soft yet durable neoprene material that fits snugly under helmets and goggles.
- XS/S fits most kids 12 and under, M/L fits most riders and XL/2XL fits larger frames (235+ lbs).
- Includes 2 replacement filters and a small storing pouch.

CAN-AM X-RACE DUST MASK

448247
XS/S, M/L, XL/2XL
Yellow (10)



CAN-AM ORIGIN DUST MASK

447833
XS/S, M/L, XL/2XL
Black (90)



CAN-AM VENTED DUST MASK





























448246
XS/S, M/L, XL/2XL
Grey (09)



WHICH CROSS HELMET IS FOR YOU? SEE COMPLETE DETAILS ON P.190-191

WHICH CROSS HELMET IS FOR YOU?

Compare. Learn. Find.

			SHELL	WEIGHT	SIZES	FEATURES	BENEFITS			
XP-R2	 XP-R2 Carbon Light Original	p.185	Carbon Fiber Composite	 Light  Very Light  Ultra Light	XS, S, M, L, XL, 2XL, 3XL	<ul style="list-style-type: none"> • Weighs only +/- 1200 g in Large size. • Tool-less multi-adjustable front peak with anti-reflecting underside. • Flexible face trim design with a large nose protector area. • F.A.S. (Full Air System) with 10 ventilation points and double rear extractor. • Integrated rear fin. • Integrated goggle anti-slip design. • Multi-density EPS foam inner shell. • Removable and washable inner liner and cheek pads. • Liner features sanitized treatment. • Front top pocket for sweat absorbing pads. • Morpho System Plus - Ergonomic 3D cheek pads. • Double-D racing buckle. • Aluminum screws, protective coated parts. • Helmet bag. • Meets or exceeds D.O.T. and ECE certifications. 	<ul style="list-style-type: none"> ▶ Less stress on neck and shoulder muscles. ▶ Allows quick visor adjustment and reduces glare. ▶ Protects from wind and snow. ▶ Allows you to control airflow for cooling. ▶ Added stability and aerodynamic performance. ▶ Keeps your helmet fresh. ▶ Promotes wicking of moisture. ▶ Allows for a better fit. ▶ Most secure fastening method. ▶ Assures lasting appearance. 	XP-R2 Carbon Light Original 447830 • D.O.T. & ECE XP-R2 Carbon Light 447656 • D.O.T. & ECE XP-R2 Carbon Light Blaze 447657 • D.O.T. & ECE		
		 XP-R2 Carbon Light							 XP-R2 Carbon Light Blaze	
XP-3	 NEW XP-3 X-Race	p.186	Fiberglass	 Light  Very Light  Ultra Light	XS, S, M, L, XL, 2XL	<ul style="list-style-type: none"> • Weighs only +/- 1470 g in Large size. • EPS inner shell. • Front and rear vent system to keep you cool. • Custom stainless steel front vent design. • Aero-tuned and fully adjustable visor system. • Removable, washable and replaceable CoolMax moisture-wicking liner and cheek pads. • Lightweight double-D chin strap. • Meets or exceeds SNELL M2015, D.O.T. and ECE certifications. 	<ul style="list-style-type: none"> ▶ Less stress on neck and shoulder muscles. ▶ Impact absorbing protection. ▶ Allows you to control airflow for cooling. ▶ Added stability and aerodynamic performance. ▶ Keeps your helmet fresh. ▶ Most secure fastening method. 	XP-3 X-Race 448395 • D.O.T., Snell & ECE XP-3 448253 • D.O.T. & Snell		
									 XP-3	
XC-4	 XC-4 Modern Heritage	p.187	Polycarbonate Composite	 Light  Very Light  Ultra Light	XS, S, M, L, XL, 2XL	<ul style="list-style-type: none"> • Weighs only +/- 1470 g in Large size. • EPS inner shell. • Front and rear vent system to keep you cool. • Custom stainless steel front vent design. • Fully-adjustable visor system. • Removable, washable and replaceable moisture-wicking liner. • Goggle strap grip. • Lightweight double-D chin strap. • Meets or exceeds SNELL M2015, D.O.T. and ECE certifications. 	<ul style="list-style-type: none"> ▶ Less stress on neck and shoulder muscles. ▶ Impact absorbing protection. ▶ Allows you to control airflow for cooling. ▶ Added stability and aerodynamic performance. ▶ Keeps your helmet fresh. ▶ Most secure fastening method. 	XC-4 Modern Heritage 448251 • D.O.T. & Snell 448340 • ECE XC-4 448255 • D.O.T. & Snell Ladies' XC-4 448397 • D.O.T. & ECE		
									 XC-4 Helmet	 NEW Ladies' XC-4 Helmet
X-1	 NEW X-1 Zone	p.188	ABS	 Light  Very Light  Ultra Light	XS, S, M, L, XL, 2XL	<ul style="list-style-type: none"> • High-tech, lightweight and tough. • Adjustable, aero-tuned visor. • Ventilation system. • Moisture-wicking and breathable chin strap, liner and cheek pads. • Easily removable and washable liner and cheek pads. • Provides maximum visibility. • Fits all goggles. • Strap grip keeps goggle strap in place. • Meets or exceeds D.O.T. certification. 	<ul style="list-style-type: none"> ▶ Less stress on neck and shoulder muscles. ▶ Added stability and aerodynamic performance. ▶ Airflow for cooling. ▶ Keeps your helmet fresh. ▶ Keeps goggles in place. 	X-1 Zone 448387 • D.O.T. X-1 447942 • D.O.T. X-1 Cross Helmet 447991 • ECE		
									 X-1	 X-1 Cross Helmet
ENDURO	 Enduro Camo	p.189	Polycarbonate Composite	 Light  Very Light  Ultra Light	S, M, L, XL, 2XL, 3XL	<ul style="list-style-type: none"> • Advanced polycarbonate alloy shell. • Versatile visor design. • Multi-position, ratcheted face shield. • Dual-density EPS foam inner shell. • Easily removable and washable liner and cheek pads. • 16-vent intake and exhaust system. • S to 3XL, meets D.O.T. and ECE certifications. (3XL, D.O.T. only). 	<ul style="list-style-type: none"> ▶ High-impact resistance. ▶ Allows for use with goggles or shield. ▶ Enhanced impact absorption. ▶ Keeps your helmet fresh. ▶ Superior aeration and cooling. 	Enduro Camo 448282 • D.O.T. & ECE Enduro 448259 • D.O.T. & ECE		
									 Enduro	

Some products shown may not be available or homologated in your country. Contact your BRP dealer for local details.

OPEN FACE HELMET*

You do trail riding or simply work and play on your land, and you want to be able to drink, eat or talk without taking your helmet off? The open face helmet is for you. It also offers maximum airflow.

ST-5 BASIC, COMFORTABLE AND INEXPENSIVE WITH A COOL RETRO OPTION.



ST-5 OPEN FACE HELMET

- Weight +/- 1050 g in Large size.
 - Injection molded shell.
 - 3-snap visor included.
 - Comfortable head liner and cheek pad fabric.
- Shell: Thermoplastic Composite
447880 • XS, S, M, L, XL, 2XL • Black (90)

DOT ECE22.05

ST-2 LIGHTWEIGHT FIBERGLASS HELMET IN A RETRO DESIGN WITH MODERN DETAILS.



ST-2 OPEN FACE HELMET

- Weight +/- 1200 g in Large size.
 - Sport visor peak with sunshield.
 - Soft and comfortable head liner and cheek pad fabric.
- Shell: Fiberglass
447884 • XS, S, M, L, XL, 2XL, 3XL • White (01), Black (90)

DOT ECE22.05

FULL FACE HELMETS*

If you ride in cold areas, choose the Modular Helmet. Its full coverage, sealed design will keep you warm while providing great vision. With a modular-style helmet, you can easily stop and talk with your riding group or grab a snack.

MODULAR 3 OUTSTANDING VISION WITH CRYSTAL CLEAR VISOR AND BREATH EVAC SYSTEM TO PREVENT FOGGING.

MODULAR 3 HELMET

- Clear Vision Technology with optically-correct dual lens visor.
- Front push-button release integrated into jaw section facilitates manipulation when wearing gloves.
- Adjustable sunshield lowers or raises at the touch of a button.
- BREATH EVAC fog-resistant mask system and increased vent diameter control breathing airflow.
- Quick-release chin strap.
- Spacious design allows room for eyeglasses.
- D.O.T. approved.

Shell: Polycarbonate Composite
447963 • S, M, L, XL, 2XL, 3XL

- White (01),
- Grey (09),
- Hi-Vis Yellow (26),
- Black (90)



MODULAR 3 ELECTRIC SE HELMET

(Not illustrated)
• All the great features of the new Modular 3 helmet, plus an electric shield for extra protection against fogging.

Shell: Polycarbonate Composite
447964 • S, M, L, XL, 2XL, 3XL • Black (90)

DOT

DOT



SENA 20S BLUETOOTH COMMUNICATION SYSTEM

- Super-versatile, water-resistant multi-function Bluetooth communication, navigation and music system designed for outdoor and vehicle sound environment use.
- Driver-to-passenger and driver-to-driver communication at a range over 1.2 miles (2 km).
- Up to 12-hour talk and 10-day stand-by time on a single charge – permits simultaneous charge and play.
- 4-way conference, smartphone, intercom-to-phone connection, GPS and mp3 music playback via AVRCP operation, or easy-adjust manual operation with exclusive Jog Dial.

- Bluetooth technology allows for seamless connection with stereo headset, mp3 players, and smartphones.
- Voice-prompt feedback, clear and natural sound quality, individual volume control for each audio source, fully-integrated audio booster delivers optimal sound level – fully firmware-upgradable.
- Complete with integrated microphone, wired microphone, wired boom microphone, speakers, plus mp3, earbud, and GPS ports.

NEW

SENA 20S BLUETOOTH COMMUNICATION SYSTEM

Single Pack
448207 • One size
Black (90)

Dual Pack
448208 • One size
Black (90)



BLUETOOTH COMMUNICATION SYSTEM

- Bluetooth v3.0 Stereo Headset with long-range Bluetooth Intercom.
- 4-way conference intercom.
- Multipoint for mobile phone and GPS.
- Voice prompts.
- Bluetooth stereo headset for Bluetooth audio devices such as MP3 players.
- Bluetooth music playback control by AVRCP: play, pause, track forward and track back.
- Easy operation through versatile Jog Dial (Patent Pending).

- Sufficient sound level with integrated audio booster.
- Bluetooth handsfree for Bluetooth mobile phones.
- Bluetooth headset or stereo headset for Bluetooth GPS navigation.
- Stereo music through 3.5 mm audio cable.
- Crystal clear and natural sound quality.
- Up to 12 hours talk time, 10 days stand-by time.
- Can be used while charging.
- Individual volume control for each audio source.
- Bluetooth specification v3.0.
- Firmware upgradable.

BLUETOOTH COMMUNICATION SYSTEM

Single Pack
447714
One size • Black (90)

Dual Pack
447715
One size • Black (90)





CAN-AM ADVENTURE SPEED STRAP GOGGLES BY SCOTT

- No Fog anti-fog lens treatment.
- Clear Lexan lens.
- Multi-layer face foam.
- Durable rubber-threaded strap.
- Tear-off and roll-off compatible (sold separately).
- Clever and easy attachment system.

447934
One size
White (01), Yellow (10), Black (90)



CAN-AM ADVENTURE OVER THE GLASSES GOGGLES BY SCOTT

- Same great features as the Can-Am Adventure goggles, engineered to fit comfortably with prescription eyeglasses.

447901
One size • Black (90)



SPEED STRAP HELMET ATTACHMENT SYSTEM

- Quick fastening system features enhancements not found in other similar systems.
- Proven pivot design provides secure and easy-to-use durable attachment to any helmet.
- On-the-fly strap tension adjustment for riders on the go.

447912
One size • Black (90)



CAN-AM TRAIL GOGGLES BY SCOTT

- 100% UV protected clear Lexan lens.
- Hypoallergenic super-soft face foam.
- Durable anti-slip strap.
- Tear-off and roll-off compatible (sold separately).

447899
One size
White (01), Yellow (10), Black (90)



CAN-AM RACE SAND GOGGLES BY SCOTT

- Integrated custom painted frame and strap graphics.
- No Fog¹ anti-fog lens treatment.
- 100% UV protected grey Lexan[†] lens.
- Multi-layer face foam.
- Durable anti-slip strap.
- Tear-off and roll-off compatible (sold separately).
- Dust catcher vent foam.

448224 • One size • Yellow (10), Charcoal Grey (07)



CAN-AM ADVENTURE GOGGLES BY SCOTT

- No Fog anti-fog lens treatment.
- Clear Lexan lens.
- Multi-layer face foam.
- Durable anti-slip strap.
- Tear-off and roll-off compatible (sold separately).

447900
One size • White (01), Yellow (10), Black (90)



CAN-AM WORKS FILM SYSTEM BY SCOTT

- 1 anti-stick replacement lens.
- 2 rolls of film.
- 1 mud flap.
- 6 tear-offs.

447908
One size • Clear (00)



CAN-AM WORKS SINGLE LENS TEAR-OFF BY SCOTT

- 1 clear replacement lens.
- 6 tear-offs.
- 2 posts included.

447910
One size • Clear (00)



GOGGLES REPLACEMENT SINGLE LENS

- Impact-resistant polycarbonate.
- No Fog anti-fog lens treatment.

447905
One size • Clear (00), Grey (09)

448225
One size • Mirror Silver (22)



GOGGLES REPLACEMENT DUAL LENS

- Impact-resistant polycarbonate.
- No Fog anti-fog lens treatment.

447906
One size • Clear (00), Pink (36)

Replacement parts are compatible with all Can-Am Goggles by Scott, except Junior Goggles.

Some products shown may not be available or homologated in your country. Contact your BRP dealer for local details.

NEW

X-RACE GLOVES

- Air mesh panels and perforated palm for ventilation and mobility.
- Double Clarino® layer at palm and thumb for extra durability and comfort.
- Knuckle gussets for better mobility.
- Pre-curved design.
- Silicone at fingertips for added grip and control.
- Direct-injection details on back hand.
- Hook-and-loop wrist closure system to keep glove in place.

MEN'S
Air Mesh, Spandex, Clarino
286561
S, M, L, XL, 2XL
Charcoal Grey (07),
Blue (80)



LADIES'
35% Synthetic Leather,
30% Polyester, 15% Lycra,
10% Nylon,
10% Neoprene
286617
S, M, L, XL, 2XL
Pink (36),
White (01)



ACTION GLOVES

- Lightly insulated back-of-hand for chilly days.
 - Protective neoprene-covered knuckles.
 - Stretch fabric improves mobility.
 - Comfortable dual-layer Clarino on palm and thumb improves durability.
 - Pre-curved design.
 - Hook-and-loop wrist closure keeps glove secure.
- 71% Nylon, 18% Polyurethane, 4% Spandex,
4% Chloroprene Rubber, 3% Polyester
Insulation: 65% Olefin, 35% Polyester
286580 • S, M, L, XL, 2XL, 3XL
Black (90)



NEW

TEAM GLOVES

- Spandex construction for flexibility.
 - Chamude palm.
 - Pre-curved design.
 - Non-fading sublimated graphics.
 - Easy slip-on/slip-off convenience.
- Shell: Spandex, Chamude, Polyester
286554 • S, M, L, XL, 2XL, 3XL
Charcoal Grey (07)



RANCH HEAVY DUTY GLOVES

- Full leather gloves.
 - Durable double-layer sueded palm.
 - Elastic wrist for slip-on/slip-off convenience.
- 100% Cow Leather
286563 • S, M, L, XL, 2XL, 3XL
Beige (02)

MOSSY OAK CAMO GLOVES

- Matches ATV/Side-by-side Mossy Oak Break-Up Country Camo pattern.
 - 4 oz insulation keeps out the cold.
 - Quick, easy forefinger trigger* access.
 - Extra-durable leather-layered palm provides added grip.
 - Hipora™ waterproof/windproof/breathable insert.
- 85% Polyester, 15% Leather
Insulation: 100% Polyester
286572 • M, L, XL, 2XL, 3XL • Mossy Oak Break-Up Country Camo (37)

- Velcro® wrist adjustment.
 - Pre-shaped fingers.
 - Large gauntlet ensures proper jacket-sleeve overlap.
- * Forefinger area not completely waterproofed.



WINTER RIDING GLOVES AND MITTS

- mcFIT™ technology to improve grip at palm.
 - Extra warm nylon gloves with leather palm.
 - Removable antibacterial, stay-dry moisture management lining.
 - Gloves with visor-wiping cotton terry left thumb for clearing water, snow or fog.
 - Reflective details.
- Nylon, Leather
Insulation: Primaloft Gold

mcFit stands for Maximum Comfort Fit because the membrane and outer shell are laminated together. Gloves using this technology are more flexible and ultimately result in a better feel.



GLOVES
286582
S, M, L, XL, 2XL
Black (90)

MITTS
286583
S, M, L, XL, 2XL
Black (90)



NEW

X-RACE JERSEY

- Ultralight, quick-dry, antibacterial and moisture-wicking fabric.
 - Mesh fabric for maximum breathability.
- 100% Polyester
286614 • S, M, L, XL, 2XL, 3XL
Orange (12), Blue (80)

- Extended back for coverage while riding.
- Non-fading sublimated graphics.
- Rib cuffs.



NEW

TEAM JERSEY

- Quick-dry, antibacterial moisture-wicking fabric.
 - Extended back for coverage while riding.
 - Non-fading sublimated graphics.
 - Rib cuffs.
- 100% Polyester
286553 • S, M, L, XL, 2XL, 3XL • Khaki (05), Yellow (10)

MOSSY OAK CAMO JERSEY

- Ultralight, quick-dry, antibacterial moisture-wicking fabric.
 - Extended back improves coverage.
 - Non-fade sublimated Mossy Oak Break-Up Country Camo fabric matches ATV/Side-by-side pattern.
- 100% Polyester
286606 • M, L, XL, 2XL, 3XL
Mossy Oak Break-Up Country Camo (37)



NEW

LADIES' TEAM JERSEY

- Semi-fitted lady's cut.
 - Quick-dry, antibacterial, moisture-wicking fabric for maximum comfort.
 - Mesh fabric for extra ventilation underarms and side seam.
 - Rib cuff.
- 90% Polyester, 10% Spandex
286616 • XS, S, M, L, XL, 2XL
Pink (36), Teal (74)





You can zip off sleeves to wear this jacket as a vest in warmer conditions and sleeves can be stored in lower back large pocket.



MEN'S RIDING JACKET

- Highly resistant, Teflon[®]-treated with RPM waterproof and breathable technology.
- Double-stitch construction throughout.
- Critical seams sealed.
- Double front flap and adjustable wrists and hem.
- Small opening at left shoulder for hydration
- pack water delivery tube (not included).
- Large ventilation at chest, sleeves and back for maximum breathability and good airflow.
- Shaped sleeves.
- Sleeves can be stored in lower large back pocket.
- Multiple pockets.
- Mesh lining.
- Reflective details.
- Jacket-to-pants connector.

286390 • XS, S, M, L, XL, 2XL, 3XL • Yellow (10), Camo (37), Black (90)



MOSSY OAK CAMO JACKET

- Stealthy-silent waterproof Mossy Oak Break-Up Country Camo fabric matches ATV/Side-by-side pattern.
- Fully-sealed seams.
- Sleeve and side seam ventilation evacuates moisture.
- Detachable hood and molded visor with height-adjustment drawstring.
- Adjustable cuff with hook-and-loop tab.
- Chest pockets, 2 expandable lower pockets, plus hand-warmer pockets.
- Designed for backpack wear with easy access to vents and pockets.
- Articulated elbow with longer back tailored for riding position.

100% Polyester
286544 • M, L, XL, 2XL, 3XL
Mossy Oak Break-Up Country Camo (37)



MOSSY OAK CAMO PANTS

- Stealthy-silent waterproof Mossy Oak Break-Up Country Camo fabric matches ATV/Side-by-side pattern.
- Fully-sealed seams.
- Dual easy-access cargo pockets.
- Knee-high side zipper.
- Thinner knee and seat foam for added comfort.
- Removable suspenders.
- Articulated knee and raised back waist ideal for riding position.
- Brushed tricot lining.
- Belt loops.
- Adjustable bottom leg system.

100% Polyester
286545 • M, L, XL, 2XL, 3XL
Mossy Oak Break-Up Country Camo (37)



MEN'S ADVENTURE PANTS

- Lightweight durable pants with RPM waterproof and breathable technology.
- Stretch waterproof panel at crotch and upper back for ease of movement.
- Triple stitched construction at crotch.
- Critical seams sealed.
- Shaped knees with darts.
- Binding hem at cuff for reinforcement.
- Storm gaiters at bottom opening.
- Velcro[®] side waist adjustment.
- Side leg 2-way zipper to facilitate exit.
- Jacket-to-pants connector.
- Mesh lining.
- Belt loops.

100% Nylon
286391 • 28, 30, 32, 34, 36, 38, 40, 42, 44
Yellow (10), Camo (37), Black (90)





NEW **RPM**

STORM JACKET

- RPM MAX waterproof, windproof and breathable technology.
- Windproof DWR-treated polyester fabric.
- Fully-sealed seams.
- Double front-flap with interior rain gutter.
- Minimalist design helps repel mud and water.
- Zippered pockets at left chest and waist.
- Inner pocket with Velcro closure.
- Gussets at back armhole for ease of movement.
- Pre-shaped sleeves.
- Can-Am print at front.
- Embossed Can-Am patch at back.
- Adjustable wrists and hem.

100% Polyester

286611

S, M, L, XL, 2XL, 3XL

Khaki (05)



NEW **RPM**

STORM PANTS

- RPM MAX waterproof, windproof and breathable technology.
- Windproof DWR-treated polyester fabric.
- Fully-sealed seams.
- Zippered pocket on left leg.
- Adjustable suspenders with bib.
- Y-shape strap designed to stay securely on shoulders.
- Storm gaiters at bottom opening.
- Self-fabric gusset at crotch keeps out water and mud.
- Pre-shaped legs.
- Can-Am print at right leg.
- Reinforced inner-leg fabric.

100% Polyester

286612

S, M, L, XL, 2XL, 3XL

Khaki (05)



RANCH HEAVY DUTY JACKET

- Heavy-duty stain and water-repellent cotton canvas.
- Lightly insulated.
- Rear armhole gusset enhances mobility.
- Shaped sleeves and back tail for riding comfort.
- Multiple pockets.

100% Cotton
Insulation: 100% Polyester

286551

S, M, L, XL, 2XL, 3XL

Brown (04)



RANCH HEAVY DUTY PANTS

- Heavy-duty stain and water-repellent cotton canvas.
- 2 side-leg cargo pockets.
- Belt loops.
- Pre-shaped legs.

100% Cotton

286556

28, 30, 32, 34, 36,

38, 40, 42, 44

Brown (04)



CAN-AM WINDPROOF JACKET

- Windproof DWR-treated nylon.
- Adjusted fit.
- Sealed critical seams.
- Hand pockets, plus interior Napoleon pocket.
- Large high-visibility reflective stripes on shoulders.
- Adjustable wrists and hem.
- Jacket-pant connector.
- Pre-shaped sleeves.
- Can-Am branded on front-rear.

100% Nylon

286578

XS, S, M, L, XL, 2XL, 3XL

Black (90)



CAN-AM WINDPROOF PANTS

- Windproof DWR-treated nylon.
- Adjusted fit.
- Durable 500-denier seat fabric.
- Sealed critical seams.
- Thigh pocket.
- Elasticized waist with belt loop.
- Fitted to be worn over pants.
- Pre-shaped legs.
- Can-Am branded pocket.

100% Nylon

286579

28, 30, 32, 34, 36, 38, 40, 42, 44

Black (90)



**RPM****LADIES' RIDING JACKET**

- Highly resistant, Teflon[®]-treated nylon with RPM waterproof and breathable technology.
- 500-denier nylon at hem and double stitch construction throughout.
- Critical seams sealed.
- Double front flap and adjustable wrist, hem and collar.
- Easy access collar adjustment on both sides.
- Brushed polyester at inner collar, pocket and wrist for extra comfort.
- Gussets at back armhole for ease of movement.
- Shaped elbows with expandable contrasting gussets.
- Long ventilation at side and underarm, plus additional ventilation at back for maximum airflow.
- 2 waist pockets and 1 interior zippered pocket.
- Jacket-to-pants connector.
- Reflective piping.
- Mesh lining.

100% Nylon

286294 • XS, S, M, L, XL, 2XL
Black (90)**RPM****LADIES' CROSS PANTS**

- Lightweight durable pants with RPM waterproof and breathable technology.
- 500-denier waterproof nylon at seat and bottom inseam.
- Stretch fabric waistband.
- Critical seams sealed.
- Water-resistant thigh zipper vent.
- Hip pocket with zipper and flap.
- Jacket-to-pants connector.
- Binding hem at cuff for reinforcement.
- Storm gaiters at bottom opening.
- Shaped knees with darts.
- Mesh lining.
- Belt loops.

100% Nylon

286478
4, 6, 8, 10, 12, 14 • **Black (90)****MUD JACKET**

- 100% waterproof PVC.
- Electronically-welded seams.
- Underarm and rear vent panels.
- 2 hand pockets.
- Elastic cuffs.
- Drawstring hood and hem.

Polyvinyl Chloride (PVC),
Mesh Polyester**286127** • S, M, L, XL, 2XL
Clear (00), Matte Black (93)**MUD PANTS**

- Oversized pants made of 100% waterproof PVC.
- Electronically-welded seams.
- Strategically placed ventilation.
- Side openings at bottom leg.

Polyvinyl Chloride (PVC)

286128 • S, M, L, XL, 2XL
Clear (00), Matte Black (93)**CAN-AM RIDING BOOTS**

- Rider-tough 8" lace-up-style riding boots.
- VIBRAM[®] Bifida[®] outsoles for superior performance.
- COSMO[®] HydroGuard[®] waterproofing.
- Full-grain leather upper (waterproof nubuck in beige model).
- Removable Meramec[®] Ultron[®] insoles.
- High-gusseted tongue keeps out water and debris.
- Ultra-comfortable padded collar.
- Steel toecaps.
- Abrasion-resistant TPU toe protectors.
- Double heavy-duty stitching in higher-stress areas.
- Abrasion-resistant laces.

100% Leather

444197 • 7, 8, 9, 10, 11, 12, 13*
Beige (02), Black (90)**CAN-AM NEOPRENE MUD BOOTS**

- 100% waterproof polyurethane boot.
- Neoprene upper for maximum flexibility while walking or riding.
- Lightweight and comfortable soft liner.
- Aggressive tread design for maximum grip on any surface.
- Excellent resistance to oils, grease and gasoline.

60% Polyurethane, 40% Neoprene

444196
8, 9, 10, 11, 12, 13*
Black (90)**444201**
8, 9, 10, 11, 12, 13*
Next G-1 Vista Camo (37)**CATCH THE VIDEO AT CAN-AMOFFROAD.COM**

*For European footwear equivalencies see p. 209



NEW **RPM**

WINTER RIDING JACKET

- Robust textured fabric featuring RPM waterproof, windproof and breathable technology.
- Critical seams sealed for added protection.
- Vents at underarm to enhance moisture evacuation during rigorous riding or mild weather.
- 2 waist pockets and 1 Napoleon pocket.
- Cap inner pockets.
- Cold-blocking front flap with insulated under flap uniquely designed for off-road riding windproofness.
- Powder skirt to keep wind, cold and snow from entering.
- Reflective details.
- Micro-polyester at collar and micro-fleece integrated inner wrists.
- Inside front and back panels lined with micro-fleece to add warmth and comfort.
- Easy-access collar adjustment on both sides.
- Bottom and wrist adjustments.
- Can-Am print at front and on sleeve.
- Can-Am embroidery at back.

60% Polyester, 40% Nylon
Insulation: Primaloft Black
286609 • S, M, L, XL, 2XL, 3XL • Black (90)



NEW **RPM**

WINTER RIDING HIGHPANTS

- RPM waterproof, windproof and breathable technology.
- Intelligent combination of materials specifically adapted to winter riding.
- Critical seams sealed.
- Reinforced fabric at seat and knees.
- 3/4 length side zippers with adjustable hem.
- Reflective details.
- Storm gaiter with boot lace snap-on webbing to shield snow entry.
- Pre-shaped legs.
- Bib-style pants with high back and front to keep wind and snow out.
- Adjustable suspenders with Y-shape strap designed to stay securely on shoulders.
- Fleece-lined seat.

60% Polyester, 40% Nylon
Insulation: Primaloft Black
286610 • S, M, L, XL, 2XL, 3XL
Black (90)



PRIMALOFT INSULATION



A HIGH-PERFORMANCE INSULATION WITH THE FULL SPECTRUM OF BENEFITS TO BRAVE THE ELEMENTS.

Warmer, drier, softer, and more compressable than any other synthetic insulation.



Warmth without bulk



Water resistant



Breathable

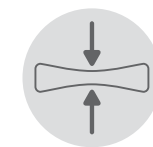

Packable



Lightweight



Superior softness

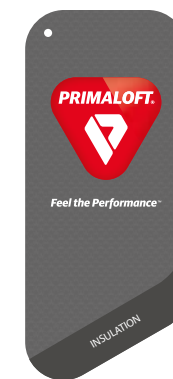

COMMITTED TO DELIVERING FEEL-GOOD PRODUCTS THAT EMPOWER YOU TO STAY IN THE MOMENT.

BLACK INSULATION

Men's and ladies' Winter Riding Jackets and Highpants use Primaloft Black insulation to give you the right amount of warmth and extra breathability.

RPM

LADIES' WINTER RIDING JACKET

- RPM MAX waterproof, windproof and breathable technology.
- Overall water-repelling Teflon[®] treatment.
- Teflon HT treatment on light colors for additional water and stain resistance.
- All seams and logo sealed.
- Shaped sleeves.
- Underarm venting.
- MP3, cell phone and additional inner pockets.
- Zippered hand pockets.
- Contrasting water-resistant zipper at chest pocket.
- Micro-fleece at collar and integrated inner wrist.
- Powder skirt.
- Front double flap.
- Adjustable collar.
- Reflective details.

100% Nylon
Insulation: Primaloft Black
286461 • XS, S, M, L, XL, 2XL, 3XL • Matte Black (93)



RPM

LADIES' WINTER RIDING HIGHPANTS

- RPM MAX waterproof, windproof and breathable technology.
- Technical, comfortable, versatile with feminine cut.
- All seams and logos sealed.
- 1000-denier nylon-lined seat, knees and inner legs.
- Polar-fleece lined seat and knees.
- Stretch-fleece bib.
- Drop seat design.
- Shaped knees.
- 2-way full-length side zippers.
- Adjustable waist.
- Hip pockets.
- Water-resistant zipper at right thigh pocket.
- Reflective details.

90% Nylon, 10% Polyester
Insulation: Primaloft Black
286460 • XS, S, M, L, XL, 2XL, 3XL
Matte Black (93)



HIGH PERFORMANCE GEAR WITH RPM TECHNOLOGY

Developed by BRP for powersports riders like you, RPM provides maximum warmth no matter how tough the ride or how cold the environment.



Critical seams and logos sealed



All seams and logos sealed



Some products shown may not be available or homologated in your country. Contact your BRP dealer for local details.

WHAT'S UNDER THE SHELL COUNTS

To keep warm, you've got to keep dry. Our technical base and mid layers wick perspiration away from your skin, where it can evaporate quickly for all-day warmth.

HOW IT WORKS

Each layer has a function. You get the best performance and versatility when you dress in a system with base layer, mid layer and outer layer.

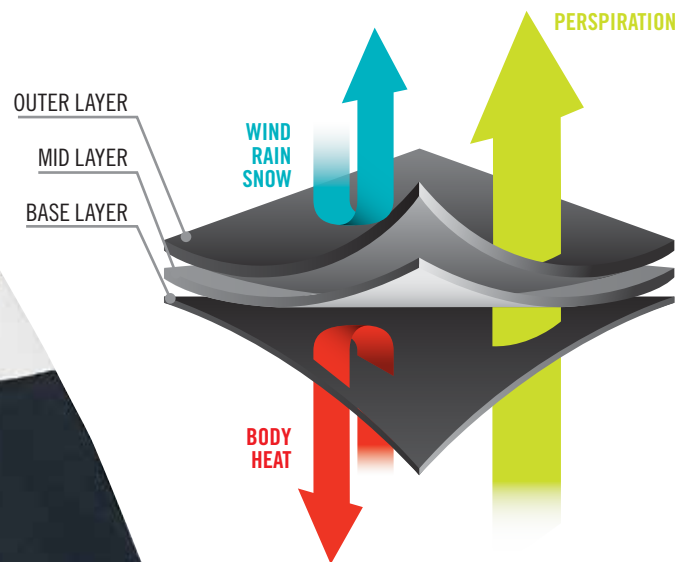

OUTER LAYER

Keeps wind and water out. Adds insulation for warmth.

MID LAYER

Dials in your warmth level. Add or remove during the day as conditions change.

BASE LAYER

Close to the body to wick perspiration and prevent chills. Adds warmth. Avoid cotton — it gets wet and stays wet.

TECHNICAL FIBERS

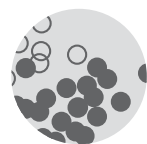

X-STATIC
X-STATIC eliminates 99.9% of bacteria to prevent odors.

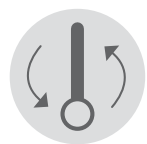

MERINO WOOL
Excellent at regulating body temperature, even when damp.

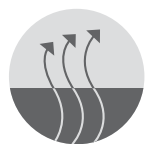

COCONUT FIBER
Natural material increases breathability by 40%.

BASE LAYER

MEN'S ACTIVE BASE LAYER

- X-STATIC[®] enhanced through to the fiber to thermodynamically regulate your temperature by conducting body heat out in warm weather and reflecting body heat back to the skin in cold weather.
 - Permanently treated for long-lasting antibacterial performance undiminished even after 250 washes.
 - Silver woven into fiber immediately binds with odor-causing agents such as ammonia and denatured proteins to instantly reduce odor.
 - Mesh panels in specific areas for better ventilation and accelerated drying.
 - Compressed for added comfort.
- 92% Polyester, 6% Spandex, 2% X-STATIC[®]



TOP
286332
M, L, XL, 2XL, 3XL
Black (90)

BOTTOM
286333
M, L, XL, 2XL, 3XL
Black (90)

MEN'S ULTRALIGHT BASE LAYER

- Coconut fibered to actively promote evaporative cooling and odor absorption, and to filter moisture out while trapping warmth in.
 - Mesh paneled in specific areas for better ventilation and accelerated drying.
 - Spandexed for ease of movement.
- 68% Polyester, 32% Coconut Fiber



TOP
286338
M, L, XL, 2XL, 3XL
Charcoal Grey (07)

BOTTOM
286339
M, L, XL, 2XL, 3XL
Charcoal Grey (07)

MEN'S & LADIES' THERMAL BASE LAYER

- Made of high-filament polyester enhanced by slight brushing to provide softness and warmth.
 - Spandex Spandered for ease of movement.
- 95% Polyester, 5% Spandex (brushed)

MEN'S TOP
286334
M, L, XL, 2XL, 3XL
Charcoal Grey (07)

MEN'S BOTTOM
286335
M, L, XL, 2XL, 3XL
Charcoal Grey (07)



LADIES' TOP
286336
XS, S, M, L, XL, 2XL
White (01)

LADIES' BOTTOM
286337
XS, S, M, L, XL, 2XL
Charcoal Grey (07)



NECK AND BODY CORE PROTECTION



WINDPROOF LAYER

- Coverage for your crucial body core.
 - Windproof, warm and breathable layer.
 - Stretch fabric and unrestricted arm movement.
 - Zipper on shoulder for easy slip on/off, even with a helmet.
 - Flatlock seams to prevent skin chafing.
- 100% Polyester
286348
S, M, L, XL, 2XL • Black (90)



NECK GAITER

- 14 oz anti-pilling fleece.
 - Spandex binding for a better fit.
- 100% Polyester
286331
One size • Black (90)

SOCKS

ULTRALIGHT SOCKS

- Warm and comfortable moisture-wicking for dry feet at all times.
 - Extreme resistance to cold and active management of perspiration moisture.
 - Dri-release[®] wool combines ease of care of synthetic fabric and look of natural fiber.
 - Elastic ankle and arch support.
 - Stay-up comfort top keeps socks up.
- 49% Polyester, 25% Polyamide Nylon, 17% Polypropylene, 7% Merino Wool, 2% Elastane
286340 • S/M, L/XL • Black (90)



THERMAL SOCKS

- Same thickness as competing thermal socks, but lighter, warmer and with better moisture-wicking performance.
 - Elastic ankle and arch support for pro feel.
 - Thermolite[®] hollow-core fibers deliver new generation of warmth-comfort fusion.
 - Stay-up comfort top keeps socks up.
 - Fully cushioned shin segment.
- 50% Polyester Thermolite[®], 32% Polyamide Nylon, 13% Merino Wool, 3% Acrylic, 2% Elastane
286341 • S/M, L/XL • Black (90)



17%
MERINO
WOOL

CAN-AM CARRIER 8800 GEAR BAG BY OGIO

- Heavy-duty chassis with oversized treaded wheels.
- Wide mouth U-shaped opening for easy access to all gear.
- Large main ventilated compartment and multi-use dual end pockets.
- Secondary end pocket with accessory organization sleeves for smaller gear.
- iFOM[®] integrated foam panel construction throughout for added gear protection.
- Telescoping pull handle and padded adjustable shoulder strap.
- Easy grab end handles for transport.
- Dimensions: 15" H x 18" W x 32" D (38 cm x 46 cm x 81 cm).

90% Polyester, 10% Plastic

447854

One size

Black (90)



CAN-AM CARRIER DUFFLE BAG BY OGIO

- High tensile strength, durable, lightweight construction.
- Ventilated shoe compartment (holds 2 pairs).
- Zippered front accessory pocket.
- Large main compartment with additional end storage pocket.
- Padded, ventilated, and adjustable shoulder strap.
- Molded carry handle.
- Durable abrasion-resistant base.
- High visibility liner.
- Dimensions: 11" H x 9.75" W x 25" D (28 cm x 25 cm x 64 cm).

100% Polyester

447856

One size

Black (90)



CAN-AM CARRIER DRY BACKPACK BY OGIO

- Completely waterproof rolltop design.
- Constructed of 420-denier nylon for durability.
- Dual-density shoulder straps and adjustable sternum strap.
- Quick-access front pocket.
- Organization panel with 2 zip pockets on inside.
- Laptop and tablet sleeves.
- 360-degree reflective print.
- Removable high-visibility liner.
- Dimensions: 20.5" H (rolled) x 10.5" W x 6.75" D (52 cm x 27 cm x 17 cm).

100% Polyester

469544

One size

Black (90)



CAN-AM CARRIER BACKPACK BY OGIO

- Padded interior laptop compartment fits most 17" laptops.
- iFom integrated panels keep your electronics and other valuables protected.
- Padded iPad[®], tablet or e-reader sleeve.
- Large main compartment.
- Comfortable padded back panel.
- Adjustable ergonomic shoulder straps.
- Zippered fleece lined top pocket for valuables.
- Dual side beverage or accessory holders.
- Dimensions: 19" H x 13" W x 7.5" D (48 cm x 83 cm x 19 cm).

100% Polyester

447858

One size

Black (90)



CAN-AM CARRIER 9800 GEAR BAG BY OGIO

- Structural Load Equalization Deck (SLED) wheeled chassis system.
- Wide mouth lid opening for easy access to all compartments and specialty pockets.
- iFOM integrated foam panel construction throughout entire bag for added protection.
- Adjustable main compartment dividers for custom organization.
- Multiple zippered mesh organization pockets for garment, shoes, and accessories.
- Front accessory pocket and secure hold compression straps.
- Oversized heavy-duty treaded wheels.
- Telescoping pull handle.
- Dimensions: 16" H x 17" W x 36" D (40 cm x 43 cm x 91 cm).

75% Polyester, 25% Plastic

447853

One size

Black (90)



CAN-AM CARRIER HEAD CASE BY OGIO

- Oversized helmet bag fits all helmet brands and sizes with fins and without.
- iFOM integrated foam panels and additional fleece interior provide the ultimate protection.
- Protective zipper teeth closure prevents scratches from zippers.
- Easy access oversized external sleeve pocket.
- Exterior zippered accessory pocket.
- Durable reinforced bottom.
- Dimensions: 11" H x 13" W x 19" D (28 cm x 33 cm x 48 cm).

100% Polyester

447857

One size

Black (90)



CAN-AM HELMET CASE

- Easy-to-carry ergonomic handle.
- Outer pocket for helmet accessory.

100% Polyester

447678

One size

Black (90)



HOW TO MEASURE

- For best results, have someone else take measurements.
- Measure body in underwear.
- Tape must be snug but not tight.
- If measurements fall between two sizes, order the larger size.

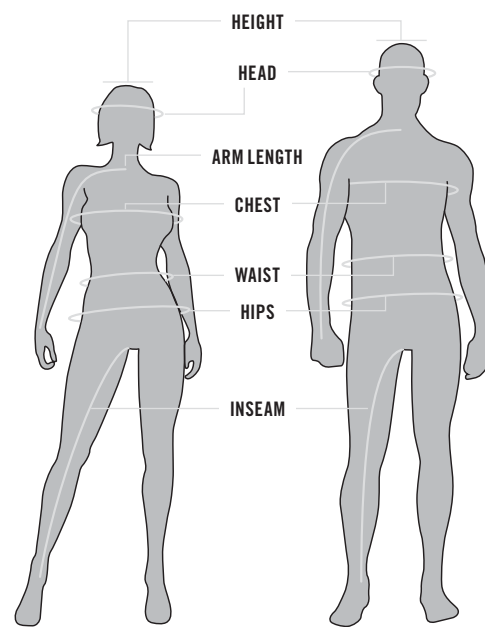

Chest/Bust: Measure under your arms, around the fullest part of your chest.

Waist: Measure around your natural waistline, keeping one finger between the tape and body.

Gloves: Measure palm width.

Inseam: Without shoes, from crotch to the floor.

Arm length: Hand on hip, from center back neck bone, along shoulder point round elbow to bottom of wrist bone.

Head: Around your head, from the center of the forehead, above the ears and over the natural bump at the back of the head.

WHAT CODE REPRESENTS YOUR SIZE?

1. Find your size.
2. The corresponding code is **THE CODE** you use to complete the part number on your order.
Example: 440227__90 Size: M = Code "06", therefore 4402270690

SIZE	CODE	SIZE	CODE	SIZE	CODE
One Size	00	L/XL	73	10	30
XS	02	2	21	10.5	99
XS/S	90	3/4	79	11	31
S	04	5/6	52	12	32
M	06	6/8	48	13	33
MT	07	7/8	54	14	34
L	09	9/10	55	28	36
LT	10	10/12	49	30	37
XL	12	11/12	56	32	38
XLT	13	13/14	80	34	39
2XL	14	14/16	50	36	40
3XL	16	4	23	38	41
4XL	18	6	25	40	42
5XL	88	7	27	42	43
S/M	72	8	28	44	44
M/L	91	9	29		

MEN'S - REGULAR 1,77 M - 1,83 M BODY MEASUREMENTS

	S	M	L	XL	2XL	3XL
CHEST	89-94	94-102	102-112	112-122	122-132	132-142
WAIST	74-79	79-86	86-97	97-107	107-117	117-127
HIPS	89-94	94-102	102-112	112-122	122-132	132-142
ARM LENGTH	79-81	81-84	84-86	86-89	89	89-91
INSEAM	80-81	81	81	81	81-82	82-83

MEN'S - REGULAR - TALL 1,86 M - 1,95 M

	MT	LT	XLT
CHEST	94-102	102-112	112-122
WAIST	79-86	86-97	97-107
HIPS	94-102	102-112	112-122
ARM LENGTH	85-88	88-90	90-93
INSEAM	86	86	86

MEN'S - REGULAR NUMERIC (PANTS) 1,77 M - 1,83 M

	28	30	32	34	36	38	40	42	44
CHEST	89-91	91-97	97-99	99-104	104-109	109-114	114-119	119-124	124-130
WAIST	71-76	76-80	80-84	84-89	89-94	94-99	99-104	104-109	109-114
HIPS	89-91	91-97	97-99	99-104	104-109	109-114	114-119	119-124	124-130
INSEAM	79	80	81	81	81	81	81	81	81

LADIES' - REGULAR 1,64 M - 1,77 M

	XS	S	M	L	XL	2XL	3XL
CHEST	81-86	86-91	91-99	99-107	107-114	114-124	124-134
WAIST	61-66	66-71	71-76	76-86	86-94	94-104	104-114
HIPS	86-91	91-97	97-102	102-112	112-119	119-132	132-140
ARM LENGTH	79	79-81	81	81-83	83	83-86	86
INSEAM	76	76	76	76	76	76-77	77

LADIES' - REGULAR NUMERIC (PANTS) 1,64 M - 1,77 M

	4	6	8	10	12	14
CHEST	81-86	86-91	91-97	97-102	102-107	107-112
WAIST	61-66	66-71	71-76	76-81	81-86	86-91
HIPS	86-91	91-97	97-102	102-107	107-112	112-117
INSEAM	76	76	76	76	76	76

MEN'S GLOVES (MEASURE PALM WIDTH)

	S	M	L	XL	2XL	3XL
CM	7.5	8.5	9.5	10.5	11.5	14

LADIES' GLOVES (MEASURE PALM WIDTH)

	S	M	L	XL	2XL
CM	6.8	7.5	8.3	9	11.5

JUNIOR HELMETS

	S	M	L
HAT SIZE	6 1/8 - 6 1/4	6 3/8 - 6 1/2	6 5/8 - 6 3/4
HEAD (CM)	49-50	51-52	53-54

TEEN GLOVES

	6-8	10-12	14-16
CM	8	8.5	9

SOCKS

	S/M	L/XL
	6-9	10-13

HELMETS

	XS	S	S/M	M	M/L	L	XL	2XL	3XL
HAT SIZE	6 1/8 - 6 3/4	6 3/8 - 7	7 1/8	7 1/8 - 7 1/4	7 1/4	7 3/8 - 7 1/2	7 3/8 - 7 3/4	7 7/8 - 8	8 1/8 - 8 1/4
HEAD (CM)	53-54	55-56	57	57-58	58	59-60	61-62	65-66	65-66

KIDS/TEEN

	2	3/4	5/6	7/8	10/12	14/16
CHEST	53	56-58	61-64	66-69	73-76	79-84
WAIST	51	52-53	55-46	57-58	61-64	66-69
HIP (SEAT)	53	56-58	61-64	66-69	72-76	79-84
ARM LENGTH	39	46-47	51-55	58-62	72-76	79-84
INSEAM	34	39-44	50-53	57-62	66-71	74-79

FOOTWEAR EQUIVALENCIES

	US					
CAN-AM NEOPRENE MUD BOOT	US	8	9	10	11	12
	EU	41	42	43	44	45
CAN-AM RIDING BOOT	US	7	8	9	10	11
	EU	39.5	41	42.5	44	45.5

GENUINE BRP PARTS.

BY USING ORIGINAL BRP PARTS,
YOU ARE TAKING CARE OF YOUR INVESTMENT.
MAKE THE RIGHT CHOICE.



LEARN MORE
ON PAGE 212

PERFORMANCE DRIVE BELT

- High-performance design ideal for off-road use.
- BRP-specific calibration adjusted to best suit your Can-Am vehicle.
- Ask your authorized Can-Am dealer which one fits your vehicle.

715000302 715900024 715900023

PULLER/LOCKING TOOL

- (Not illustrated)
- Spreads the secondary clutch open for easy belt replacement.
- Locks engine at TDC for maintenance tasks.

529036098

PERFORMANCE DRIVE BELT (100% PBO)

- High-performance belt technology.
- 100% cutting-edge PBO high-tensile strength polymer fibre construction.
- Designed for high-temperature robustness and prolonged durability.
- Ask your authorized Can-Am dealer which one fits your vehicle.

715900212

CV BOOT KITS

- Come with clamps and grease.
- Genuine BRP CV Boot Kits ensure absolute compatibility and a perfect fit.
- Ask your authorized Can-Am dealer which one fits your vehicle.



ORGANIC BRAKE PAD KIT

- Chosen as the standard OEM on Can-Am ATV.
- Provides excellent braking capacity with optimal efficiency, a great feel, and low noise.

Fits: G2 2013 & up (except with 400 engine), G2 2012 with 800R or 100 engine (except MAX models), G2L 2015 & up, G2S 2012 & up (except G2S 2012 with 500 engine)

Front Left Front and Rear Right
705601015 705601014



METALLIC BRAKE PAD KIT

- Built strong to last long – heavy-duty construction stands up to hard braking.
- Designed to handle demanding riding conditions with challenging braking environments such as mud and dunes.
- Created specifically for use with Can-Am ATV.

Fits: G2 2013 & up (except with 400 engine), G2 2012 with 800R or 100 engine (except MAX models), G2L 2015 & up, G2S 2012 & up (except G2S 2012 with 500 engine)

Front Left Front and Rear Right
715900248 715900249



AIR FILTERS

- Prevent airborne contaminants from reaching your engine.
- Protect internal components against premature wear.
- Genuine BRP air filters ensure absolute compatibility and a perfect fit.
- Ask your authorized Can-Am dealer which one fits your vehicle.



TOUCH UP PEN

- Ideal for do-it-yourself small paint repairs caused by rock chips and scratches on your bumpers, roll cage, a-arms, springs, beadlocks, etc.
- Genuine Can-Am color perfectly matches original paint for seamless coverage.
- For use on metal parts only.

529036363 - Can-Am Red
529036362 - Manta Green
529000084 - Octane Blue



YUASA[†] BATTERIES

- Top of the line models from the leading preferred original equipment battery supplier in North America.

18 Amps. Wet
(YTX20L-BS) - 410301203

19 Amps. Dry
(YB16CL-B) - 278001756

13 Amps. Wet
(YTX15L-BS) - 710000283



NEW

30 AH BATTERY UPGRADE

- Requires 1 additional bolt and 1 washer (207562054 & 234062410).
- Please refer to your user manual for removal and insulation.
- Stock on XT & XT CAB.

Fits: UR (Base & DPS models)
515176151



YUASA[†] AUTOMATIC 1 AMP BATTERY CHARGER

- Keeps your battery charged and ready to ride.
- Hook it up – plug it in – charge. Includes adapter and clips.
- 3-stage charge cycle switches automatically to maintenance mode.
- Easy-to-read 3-color LED charge monitor.
- Built-in overcharge prevention.

529036307

DRIVE BELTS

The drive belt is an integral part of your off-road vehicle's transmission and its importance for achieving its maximum performance can't be overstated. All the tuning or changes made in gearing, weights, ramps and springs in the world don't matter if the belt can't consistently maintain its performance.



SO, WHAT MAKES A BELT STAND OUT?

You see that several elements include "Aramid." Aramid is a man-made fiber resistant to heat and abrasion. It is used to add strength and long life to the rubber belt. Aramid fibers and fabrics are common in belts.

- ▶ Top Cog with Special Aramid Fiber
- ▶ Adhesion Rubber
- ▶ Specialized High Modulus Aramid Cord
- ▶ Compressive Rubber with High Modulus PBO Fiber
- ▶ Bottom Cog With Aramid Fabric

BRP BELT CONSTRUCTION VS. COMPETITORS

	Brand A	Brand A C12	Brand B	BRP
Top Rubber Chopped Fiber	CR Aramid	CR Aramid	H-NBR Aramid/Cotton	CR Aramid
Upper Adhesion Rubber Chopped Fiber	CR	CR	H-NBR	CR
Cord	Aramid	Carbon	Aramid	Aramid
Lower Adhesion Rubber Chopped Fiber	CR	CR	H-NBR	CR
Bottom Rubber Chopped Fiber	CR Aramid	CR Aramid	H-NBR Aramid/Cotton	CR PBO Aramid
Bottom Fabric	Acrylic 1 ply	Acrylic 1 ply	CR Aramid/Cotton	Aramid/PET 1 ply

CR: Chloroprene Rubber

USE THE RIGHT BELT

Just as we calibrate our clutches and gearing to deliver the best possible performance for how a vehicle is ridden, we specialize the belt for the application, too.

Different types of riding create different heat and load conditions our engineers must account for. For instance, higher drivetrain loads, like on Maverick X ds Turbo, going through the dunes on the throttle hard for extended periods of time, generally require belts with a stiff construction and high heat resistance. A utility vehicle pulling equipment or heavily loaded sees high drivetrain loads too, but the clutch calibrations, engine RPM, vehicle speed and environment differ significantly – so will the required belt.

This is why it's best to match the exact model and year of your BRP vehicle to the replacement belt. And even though BRP belts might have the same width and length dimensions, the difference in the materials delivers the best performance and longevity for your vehicle's application and calibrations.

MODULUS & TENSILE STRENGTH
(Based on BRP Dynamometer Testing)

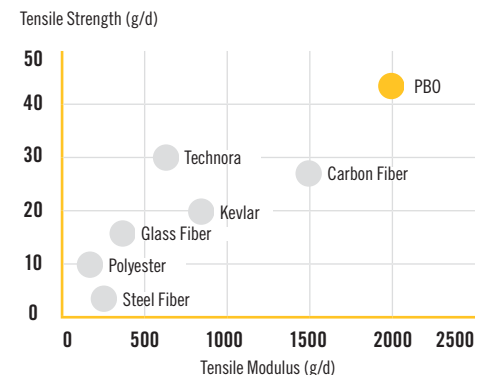

*When compared to BRP's Performance Drive Belt (100% PBO) (715900212).

DURABILITY COMPARISON*

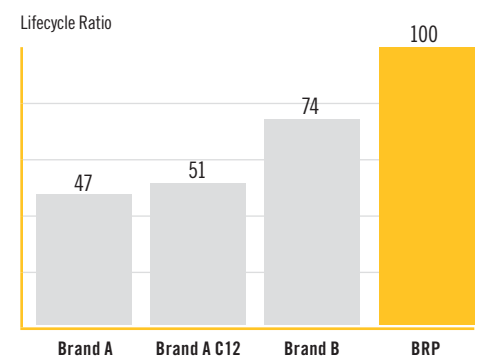

XPS ENGINE OILS AND MAINTENANCE PRODUCTS

The XPS brand has a complete family of performance products to expertly protect, enhance and extend life of your BRP vehicle. Every XPS product has been tested and approved for complete peace of mind. No second guesses, no assumptions. The exact product to use, every time.

XPS ENGINE OILS



XPS 4-STROKE SYNTHETIC OIL

- Specifically formulated and BRP-engineer-certified for use in your Can-Am vehicle.
- Premium synthetic base with custom additives provides unmatched lubrication and enhanced corrosion protection.
- Provides easier starting in cold temperature and enhanced cold start protection.

1 US gallon (3.785 L) 293600115
1 quart (946 ml) 293600112



XPS 4-STROKE SYNTHETIC BLEND OIL

- Specifically formulated and BRP-engineer-certified for use in your Can-Am vehicle.
- Synthetic blend with custom additives provides enhanced corrosion protection.

1 US gallon (3.785 L) 293600122
1 quart (946 ml) 293600121



XPS 4-STROKE OIL CHANGE KIT

- Ultra-convenient "all-in-one" oil-change kit saves time and money.
- Includes XPS Synthetic or Synthetic Blend Oil, oil filter, o-rings and washer.

For Can-Am off-road vehicles with 450 cc and less Rotax engine (except Rally® and DS™ models) Synthetic Blend • 703500902
For Can-Am off-road vehicles with 500 cc or more Rotax engine (except Traxter® or Quest models) Synthetic Blend • 703500904

Synthetic • 703500903 Synthetic • 703500905

Note: Please contact your dealer or visit our online store for suggested retail prices of oil based products. Some products shown may not be available or homologated in your country. Contact your BRP dealer for local details.

USING THE RIGHT OIL MATTERS

The right oil delivers:

THE BEST PERFORMANCE
THE BEST RELIABILITY
THE LONGEST LIFE

It's a balancing act to deliver all three attributes – and only XPS, with its custom blend formulations and carefully matched additives, is specifically designed to do just that in a Rotax engine.



“The best oil is the oil that was specifically designed for the engine, without compromising the engine.”

Mischa Zimmermann
Project Leader Engine Development, BRP



DOES ONE OIL FIT ALL?

Our efficient, high-output engines place strong demands on engine oil. At BRP, we treat oil like an actual mechanical part that is developed concurrent with our latest high-performance engine technology.

XPS 4-STROKE OILS

Fact: XPS 4-stroke oils are BRP engineer-certified for unmatched lubrication, the right characteristics for our wet clutches, the right viscosities to best protect our engines from startup to operating temperatures, and they all have extra corrosion protection to better protect your engine.

WHY CHOOSE XPS 4-STROKE ENGINE OILS INSTEAD OF LOWER-COST ALTERNATIVES?

BRP engineers and experts like Mischa Zimmermann have proven repeatedly that other brands of oil don't meet the high standards BRP desires for engines like the Rotax 4-Tec 1000 Turbo.

- Each vehicle manufacturer establishes their own lubrication standards and test criteria to validate OEM oil – this means XPS achieves a much higher standard.
- Even oil that is more expensive than XPS will not have the same custom-matched performance for Rotax engines.
- Our oil is tested on the whole lineup of vehicles and engines we manufacture – not just one or two models. Our specific testing includes real world test miles to ensure XPS meets our performance requirements as opposed to relying only on generalized, minimum specifications that most aftermarket oil brands use.

AREN'T THERE OTHER HIGH QUALITY OILS ON THE MARKET?

Yes. But no other oil is designed as an actual mechanical part during engine development like XPS. Your satisfaction matters.



FIND OUT WHY OIL MATTERS AT WWW.XPSLUBRICANTS.COM

XPS CLEANERS

XPS SPRAY CLEANER & POLISH

- Removes dirt, grease, road grime and water marks easily and quickly.
- Non petroleum based formula will not harm plastic finishes.
- 12 oz. (340 g).

219702844



XPS BRAKES & PARTS CLEANER

- A concentrated blend of solvents with a powerful blasting spray that effectively removes grease, grime, brake fluid and other contaminants from brake components and metal parts without the need for disassembly.
- Evaporates instantly and completely, leaving no residue to hinder performance.
- Contains no ozone depleters.
- 14 oz. (400 g).

219701776



XPS OFF-ROAD VEHICLE WASH

- A biodegradable non-toxic cleaner that removes mud and dried-on dirt from your off-road vehicle.
- Whether grimy from the track, the woods or the fields, this cleaner will leave your off-road vehicle sparkling.
- When used as directed, XPS Wash is safe for all off-road vehicle finishes.
- 32 oz. (946 ml).

219701702



XPS MICROFIBER TOWELS

- The latest in high-quality detailing towels.
- Made up of extremely fine fibers, their soft surfaces have been perfected for drying and polishing painted, gel coated and hard shiny surfaces.
- They are so absorbent they hold up to 7 times their weight in water.
- Machine washable means they can be used over and over again.
- Pack of 2.

219701759



XPS MAINTENANCE PRODUCTS

XPS SYNTHETIC GEAR OIL

- Exceeds API GL-5 specs and provides extra protection for a wide range of differential types.
- Formulated for extended drain intervals.
- Additional friction modifiers make it ideal for clutch-type limited slip differentials.
- Allows for higher load capacity, while providing better shear stability, and less oxidation than other synthetic or conventional gear oils.
- Superior thermal stability and relatively constant viscosity help fight wear and provide enhanced extreme-temperature performance.

75W-140
293600140

75W-90
293600043



XPS CARBON FREE

- XPS Carbon Free prevents problems inherent in Ethanol-blended fuels.
- Extends storage life of fuel up to 12 months.
- Cleans fuel system while preventing corrosion and oxidation.
- Helps keep piston rings, valves and combustion chamber carbon-free to prevent difficult starting and restore peak performance.

219702533



XPS FUEL STABILIZER

- Extends fuel life by preventing fuel breakdown during storage.
- Helps prevent difficult starting, throttle hesitation and poor performance.
- Anti-corrosive, anti-oxidant formula protects fuel system and engine.
- Prevents problems inherent in Ethanol-blended fuels.

413408601



XPS SYNTHETIC SUPENSION GREASE

- Provides optimal lubrication at temperature extremes.
- Protects against external contamination.
- Specifically formulated for use in Can-Am off-road vehicles.
- Allows suspensions to perform regardless of conditions.
- 14 oz. (400 g).

293550033



XPS DOT 4 BRAKE FLUID

- Exceeds D.O.T 3 and 4 requirements.
- Unique low-moisture formulation providing maximum protection against vapor lock.
- Recommended in Can-Am off-road vehicles.

293600131



XPS PRE-MIXED ANTIFREEZE/COOLANT

- Pre-mixed, ready-to-use.
- Exceptional 5-year extended service life.
- Provides superior heat transfer, protection against corrosion and cavitation.
- Specifically formulated for use in your Can-Am vehicle.
- Ideal as a replacement coolant in vehicles that usually use 2-year antifreeze/coolant (green).

5-year (orange)
1 quart (946 ml)
219702685



XPS LUBE

- A multipurpose lubricant that prevents rust, corrosion and moisture intrusion.
- Contains active extreme-pressure additives which provide excellent lubrication and antiwear properties.
- Comes in a spray that works upside down.
- 14 oz. (400 g).

293600016





MORE THAN JUST OIL.



XPS OILS AND ROTAX ENGINES. CREATED, DEVELOPED, AND CONSTANTLY EVOLVING TOGETHER TO WORK BEST TOGETHER.

It's all about reaching optimum performance and protection, ensuring XPS oils have no equals when used in Rotax engines, and Rotax engines have no equals when they use XPS oils.

QUALITY, INNOVATION, RELIABILITY AND PERFORMANCE GO INTO EVERY BRP VEHICLE AND INTO EVERY DROP OF XPS OIL.

Our performance requirements exceed oil certification standards, so we set our own: Testing, and retesting our oils in every Rotax engine type under a wide range of rigorous operating conditions to make sure they work the best under all conditions.

XPS IS THE ONLY OIL SPECIFICALLY ENGINEERED FOR ROTAX ENGINES.

BRP's Rotax engines are the perfect embodiment of power and technology, and only highly specialized, specially engineered XPS oils can ensure they always operate at their maximum efficiency and potential.

**XPS OILS & ROTAX ENGINES.
PARTNERS IN PERFORMANCE.**



ski-doo LYNX SEA-DOO EVINRUDE ROTAX Can-am